

SORTIMENT 2024

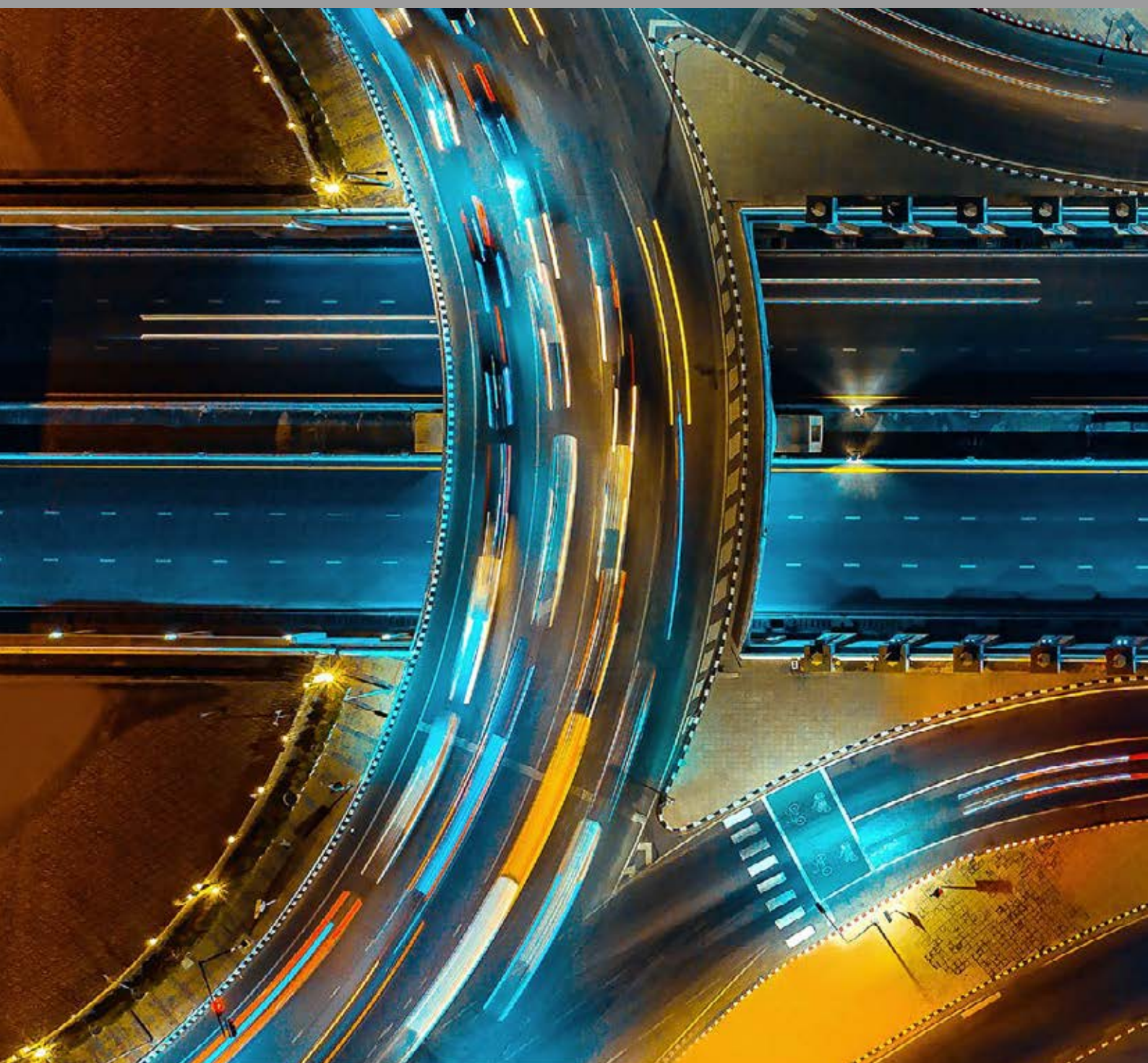

AUTOMOTIVE LIGHTING SYSTEMS

FUSES | RELAYS | HORNS



Germany



We about us

FLÖSSER products – Made in Quality – not just words, but a dedication.

From our home town Trier/Germany we have been supplying automotive lighting products related to the safety of driving for over 60 years: bulbs for cars, motor-cycles, trucks and buses, fuses, relays and also signal horns.

Not only is FLÖSSER known for high quality products, but also for providing customised service. Personal assistance, short delivery times and economical ways of transport are what we can offer besides our products to meet your demands.

We about us:

OE and aftermarket customers in and outside of Europe have made us grow to our actual size:

representations in over 40 countries, customers in more than 90 countries, a local distribution center in the USA.

This new catalogue shows you the enlarged range of our products and we trust that you will find enough interesting products to enlighten your business.

FLÖSSER – Made in Quality



À propos de nous

Produits FLÖSSER – Made in Quality – pas seulement des mots au hasard, mais un réel leitmotiv. Depuis notre siège à Trèves en Allemagne nous fournissons une variété de produits en rapport avec l'éclairage du véhicule en particulier et la sécurité automobile en général depuis plus de 60 années: ampoules auto, moto, camion et bus mais aussi fusibles, relais et klaxons (avertisseurs) font notamment partie de notre gamme. FLÖSSER s'est forgé une réputation d'excellence non seulement pour la qualité de ses produits, mais également pour la prestation de services adaptée aux besoins des clients. Aide et assistance personnalisée, temps de livraison réduits ou encore frais de transport optimisés font, outre nos produits, partie de notre palette d'offre.

Acerca de nosotros

Productos FLÖSSER – hechos en calidad – no solo un decir sino una dedicación. Desde nuestra sede central en Trier/Alemania surtimos desde hace 60 años productos de iluminación para el sector automovilístico relacionados con la seguridad en carretera: focos para autos, motocicletas, camiones y autobuses, fusibles, relevadores y también bocinas eléctricas. FLÖSSER no solo es conocido por sus productos de calidad, sino también por el servicio que le ofrece a sus clientes. La atención personal, los tiempos cortos de entrega, la forma económica de envío es lo que podemos ofrecer, además de la gama de productos para cubrir sus necesidades.

La société FLÖSSER:

Notre activité sur les marchés de l'équipement d'origine et de la seconde monte nous a permis un développement à l'export vers 90 pays dans le monde avec une représentation nationale dans 40 d'entre eux.

De même nous dirigeons un Centre de Distribution aux Etats Unis. Notre catalogue et notre site adresse vous présentent notre gamme complète.

Nous souhaitons que celui-ci vous donne des idées brillantes afin de rendre votre activité encore plus lumineuse.

FLÖSSER – Made in Quality

Nuestra compañía:

Nuestros clientes de Equipación Original y de Repuesto tanto en Europa como en el resto del mundo nos han permitido crecer hasta nuestro tamaño actual:

representantes en más de 40 países, clientes en más de 90 países, un centro de distribución en los Estados Unidos de América.

Nuestro catálogo y nuestra página web muestra la gama completa de productos FLÖSSER y estamos convencidos que encontrarán suficientes artículos de interés.

FLÖSSER – Made in Quality



Inhaltsverzeichnis · Index · Sommaire · Índice

Fahrzeuglampen · Car bulbs · Ampoules pour véhicules · Lámparas para vehículos

10 - 13	Xenonlampen · Xenon bulbs · Lampes Xenon · Lámparas Xenon
14 - 33	Halogenlampen · Halogen bulbs · Lampes halogènes · Bombillas halógenas
34 - 55	Konventionelle Lampen · Conventional bulbs · Lampes conventionnelles Lámparas convencionales
56 - 57	48 V, 58 V, 70 V & 80 V
58 - 61	Hipervision · Hiperclick
62 - 71	Upgrade Lampen · Upgrade bulbs · Ampoules de plus luminance Bombillas con más luminosidad
72 - 73	LED Frontscheinwerfer · LED headlights · LED de phare · Faro LED
74 - 77	LED retrofit
78 - 81	Blisterprogramm · Blister program · Lampes sous blister · Lámparas en blister

Sicherungen · Fuses · Fusibles · Fusibles

82 - 101	Verschiedene Sicherungen · Various fuses · Fusibles variés · Fusibles variados
102 - 103	EV Sicherungen · EV fuses · Fusibles EV · Fusibles EV
104 - 109	Sicherungshalter · Fuse holders · Porte fusibles · Porta fusibles

Relais und Blinkgeber · Relays and flashers · Relais et centrales clignotantes · Relés y destelladores

110 - 120	Mini Relais · Mini relays · Mini relais · Relevadores
121	Mikro Relais · Micro relays · Micro relais · Micro relés
122 - 123	Batterietrennrelais · Battery relays · Batterie relais · Relé de batería
124 - 125	Scheibenwischerrelais · Wiper relay · Relais d'essuie-glace · Relés de limpiaparabrisas
126 - 127	Blinkgeber · Flasher units · Centrales clignotantes · Destelladores

Signalhörner · Signal horns · Avertisseurs · Bocinas

128 - 133	Hupen und Fanfaren · Disc and fanfare horns · Avertisseurs et klaxons · Bocinas
-----------	---

Zubehör · Accessories · Accessoires · Accesorios

134 - 137	Zubehör · Accessories · Accessoires · Accesorios
138 - 141	Lampenfassungen · Bulb holders · Fiches d'ampoules · Socketes para bombillas
142	Mini Relais Sockel · Mini relay sockets · Culots pour relais mini · Portarelés para mini relés
143	Mikro Relais Sockel · Micro relay sockets · Culots pour relais micro · Portarelé para relés micro
144	Hupen Adapter · Horn adapters · Adapteurs de klaxon · Adaptadores de bocina
145 - 146	Ersatzteilkästen · Spare lamp kits · Coffrets de secours · Cajas de repuesto
147	Werkstattsortiment · Workshop kit Assortiment pour ateliers de mécanique · Surtido para talleres
148 - 155	Sicherungssortiment · Fuse Kit · Assortiment de fusibles · Surtido de fusibles
156	Verkaufsdisplay · Sales display · Kit de vente · Exhibidor de mesa





Produkt index · Product index · Index des produits · Índice de productos

158 - 204	Produkt index · Product index · Index des produits · Índice de productos
-----------	--





Zeichenerklärung · glossary · légende · glosario

V	Volt
W	Watt
	Sockel · Base · Culot · Base
i	Bezeichnung · Designation · Désignation · Designación
	Verpackungseinheit · packaging unit · unité d'emballage · unidad de embalaje
	Versandeinheit · shipping unit · unité d'expédition · unidad de envío
A	Ampere
ECE	Genehmigung nach ECE Norm · Harmonized by ECE regulation Harmonisée de ECE · Permiso de acuerdo a norma ECE
lm	Lumen
B3	Zeit nach der 3 % der getesteten Lampen ausgefallen sind time of failure for 3 % of all tested bulbs temps d'échec de 3 % de lampes testées Tiempo después de que el 3 % de los focos hayan fallado
Tc	Zeit nach der 63,2 % der getesteten Lampen ausgefallen sind time of failure for 63,2 % of all tested bulbs temps d'échec de 63,2 % de lampes testées Tiempo después de que el 63,2 % de los focos hayan fallado
	Lebensdauer · Lifetime · Durée de vie · Duración de vida
P.	Seite · Page · Page · Pagina







Fahrzeuglampen

Car bulbs

Ampoules pour véhicules

Lámparas para vehículos

Type	V	W		i		
85410	85	35	PK32d-2	D1S 4200°K	1	10
85510	85	35	PK32d-2	D1S Mega 5000°K	1	10
42322	42	35	PK32d-5	D3S Quecksilber frei mercury free	1	10
42522	42	35	PK32d-5	D3S Mega 5000°K mercury free	1	10
85409	85	35	PK32d-3	D1R 4200°K	1	10
42326	42	35	PK32d-6	D3R Quecksilber frei mercury free	1	10
85422	85	35	P32d-2	D2S 4200°K	1	10
85522	85	35	P32d-2	D2S Mega 5000°K	1	10
42422	42	35	P32d-5	D4S Quecksilber frei mercury free	1	10

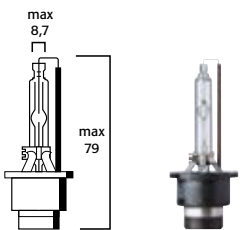
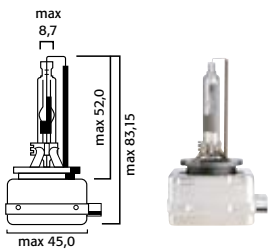
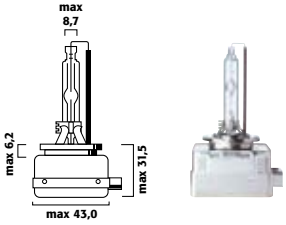

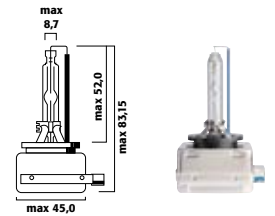
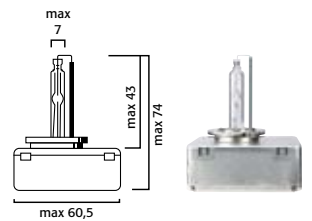
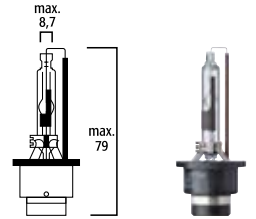

Type	V	W		i		
85426	85	35	P32d-3	D2R 4200°K	1	10
85526	85	35	P32d-3	D2R Mega 5000°K	1	10
42426	42	35	P32d-6	D4R Quecksilber frei mercury free	1	10
40722	12	25	PK32d-7	D5S 4200°K	1	1
40822	42	25	PK32d-1	D8S Quecksilber frei mercury free	1	1





Halogen Scheinwerferlampen · Halogen headlight bulbs Lampes phares halogènes · Bombillas halógenas para faros

Standard Typen · Standard types · Types homologués · Tipos homologados

Type	V	W		i		
625543	12	60/55	P43t	H4	10	100
9625543	12	60/55	P43t	H4 Blister	1	18
9003	12	60/55	P43t	H4 US (HB2 - DOT approved)	10	100
825543	24	75/70	P43t	H4	10	100
625522	12	60/55	P43t	H4 Longlife	10	100
825522	24	75/70	P43t	H4 VR LL (Vibration Resistant & Longlife)	10	100
6255333	12	60/55	P43t	H4 Megablau · megablue	10	100
6255666	12	60/55	P43t	H4 All Colors	10	100
9003333	12	60/55	P43t	H4 US Blau · blue (HB2-DOT approved)	10	100
6289043	12	60/55	P43t	H4 Mega +50%	10	100

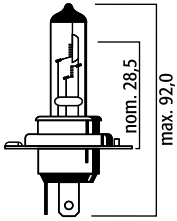

Spezial Typen · Special types · Types spéciaux · Tipos especiales

Type	V	W		i		
6290043	12	60/55	P43t	H4 Ultra +90%	10	100
96290043	12	60/55	P43t	H4 Ultra +90% Blister	1	18
6255180	12	60/55	P43t	H4 Ultra +90% Doppelbox · twinbox	1	20
6213043	12	60/55	P43t	H4 Ultra +130%	1	100
6255260	12	60/55	P43t	H4 Ultra +130% Doppelbox · twinbox	1	20
525543	12	100/55	P43t	H4 Rally	10	100
725543	12	100/90	P43t	H4 Rally	10	100
9725543	12	100/90	P43t	H4 Rally Blister	1	18
7255333	12	100/90	P43t	H4 Rally Megablau	10	100
7255666	12	100/90	P43t	H4 Rally All Colors	10	100
925543	12	130/90	P43t	H4 Super Rally	10	100
9210043	12	130/100	P43t	H4 Super Rally	10	100
8290043	24	100/90	P43t	H4 Rally	10	100
8213043	24	130/90	P43t	H4 Super Rally	10	100

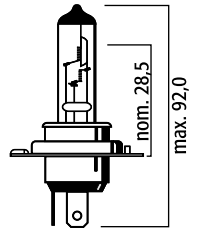



Halogen Scheinwerferlampen · Halogen headlight bulbs Lampes phares halogènes · Bombillas halógenas para faros

Nicht-Standard Typen · Non-standard types · Types non standard · Tipos no estándar

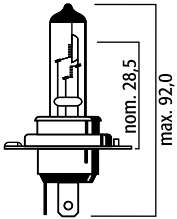

Type	V	W		i		
625545	12	60/55	P45t	H4	10	100
825545	24	75/70	P45t	H4	10	100
725545	12	100/90	P45t	H4 Rally	10	100
925545	12	130/90	P45t	H4 Super Rally	10	100
8290045	24	100/90	P45t	H4 Rally	10	100
625536	12	60/55	P36t	H4 old type	10	100

H1 Lampen · H1 Bulbs · Lampes H1 · Lámparas H1

Type	V	W		i		
3021	12	55	P14,5s	H1	10	100
93021	12	55	P14,5s	H1 Blister	1	42
3024	24	70	P14,5s	H1	10	100
302122	12	55	P14,5s	H1 Longlife	10	100
302422	24	70	P14,5s	H1 VR LL (Vibration Resistant & Longlife)	10	100
3021333	12	55	P14,5s	H1 Megablau · megablue	10	100
3021500	12	55	P14,5s	H1 Ultra White 5K 5000°K +40%	10	100
3021110	12	55	P14,5s	H1 Ultra White 5K 5000°K +40% · twinbox	1	10
3021890	12	55	P14,5s	H1 Megaplust 50%	10	100
3021680	12	55	P14,5s	H1 Megaplust 50% Doppelbox · twinbox	1	10
3021900	12	55	P14,5s	H1 Ultra +90%	10	100
93021900	12	55	P14,5s	H1 Ultra +90% · blister	1	42
3021180	12	55	P14,5s	H1 Ultra +90% Doppelbox · twinbox	1	10

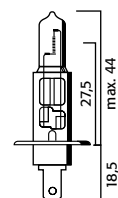

H1 Lampen · H1 Bulbs · Lampes H1 · Lámparas H1

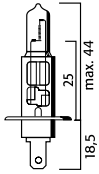



Type	V	W		i		
3021130	12	55	P14,5s	H1 Ultra +130%	1	100
3021260	12	55	P14,5s	H1 Ultra +130% Doppelbox · twinbox	1	10
3021335	12	70	P14,5s	H1 4300°K Silberblau · silverblue	10	100
3021670	12	70	P14,5s	H1 Silberblau Doppelbox silverblue twinbox	1	10
13020	12	100	P14,5s	H1 Rally	10	100
13130	12	130	P14,5s	H1 Super Rally	10	100
13024	24	100	P14,5s	H1 Rally	10	100



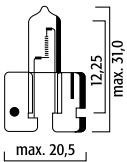

H2 Lampen · H2 Bulbs · Lampes H2 · Lámparas H2



Type	V	W		i		
3420	12	55	X511	H2	10	200
13420	12	100	X511	H2 Rally	10	200
3720	24	70	X511	H2	10	200





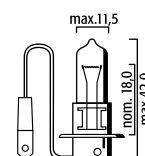

H3 Lampen · H3 Bulbs · Lampes H3 · Lámparas H3

Type	V	W		i		
3320	12	55	PK22s	H3	10	100
93320	12	55	PK22s	H3 Blister	1	36
3324	24	70	PK22s	H3	10	100
332422	24	70	PK22s	H3 VRLL (Vibration Resistant & Longlife)	10	100
3320333	12	55	PK22s	H3 Megablau · megablue	10	100
3320666	12	55	PK22s	H3 Semigold	10	100
3320900	12	55	PK22s	H3 Ultra +90%	10	100
93320900	12	55	PK22s	H3 Ultra +90% Blister	1	36
3320335	12	70	PK22s	H3 Silberblau · silverblue	10	100
13320	12	100	PK22s	H3 Rally	10	100
13330	12	130	PK22s	H3 Super Rally	10	100
13324	24	100	PK22s	H3 Rally	10	100
1332033	12	100	PK22s	H3 Rally Blau · blue	10	100
3348	48	45	PK22s	H3	10	100
3380	80	55	PK22s	H3	10	100

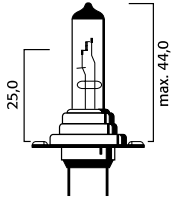



H7 Lampen · H7 Bulbs · Lampes H7 · Lámparas H7



Type	V	W		i		
2070	12	55	PX26d	H7	10	100
92070	12	55	PX26d	H7 Blister	1	24
2470	24	70	PX26d	H7	10	100
207022	12	55	PX26d	H7 Longlife	10	100
247022	24	70	PX26d	H7 VR LL (Vibration Resistant & Longlife)	10	100
2070333	12	55	PX26d	H7 Megablau · megablue	10	100
2070300	12	55	PX26d	H7 Ultra White 4200°K +30%	10	100
2070600	12	55	PX26d	H7 Ultra White 4200°K +30% Doppelbox · twinbox	1	10
2070500	12	55	PX26d	H7 Ultra White 5K 5000°K +40%	10	100
2070110	12	55	PX26d	H7 Ultra White 5K 5000°K +40% Doppelbox · twinbox	1	10
2070890	12	55	PX26d	H7 Megaplust 50%	10	100
2070680	12	55	PX26d	H7 Megaplust 50% Doppelbox · twinbox	1	10

H7 Lampen · H7 Bulbs · Lampes H7 · Lámparas H7

Type	V	W		i		
2070900	12	55	PX26d	H7 Ultra +90%	10	100
92070900	12	55	PX26d	H7 Ultra +90% Blister	1	24
2070180	12	55	PX26d	H7 Ultra +90% Doppelbox · twinbox	1	10
2070130	12	55	PX26d	H7 Ultra +130%	1	100
2070260	12	55	PX26d	H7 Ultra +130% Doppelbox · twinbox	1	10
2070666	12	55	PX26d	H7 All Colors	10	100
2070335	12	70	PX26d	H7 Silberblau · silverblue	10	100
2070670	12	70	PX26d	H7 Silberblau Doppelbox silverblue twinbox	1	10
12070	12	80	PX26d	H7 Rally	10	100



H8 Lampen · H8 Bulbs · Lampes H8 · Lámparas H8

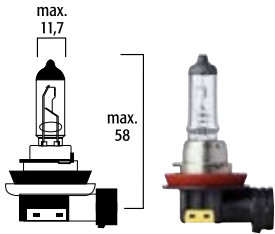

Type	V	W		i		
2080	12	35	PGJ19-1	H8	10	100
92080	12	35	PGJ19-1	H8 Blister	1	27

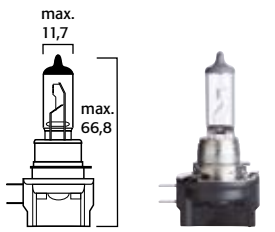

2080B	12	35	PGJY19-1	H8B gerader Sockel straight socket culot droit · base recta	1	100
-------	----	----	----------	---	---	-----





2080335	12	50	PGJ19-1	H8 Silberblau · silverblue	10	100
---------	----	----	---------	----------------------------	----	-----

12080	12	80	PGJ19-1	H8 Rally	10	100
-------	----	----	---------	----------	----	-----

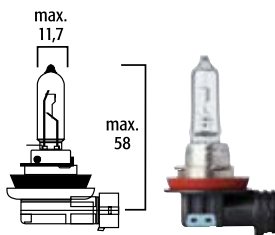
H9 Lampen · H9 Bulbs · Lampes H9 · Lámparas H9



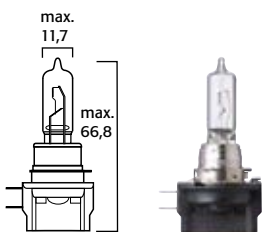

Type	V	W		i		
2090	12	65	PGJ19-5	H9	10	100
92090	12	65	PGJ19-5	H9 Blister	1	27



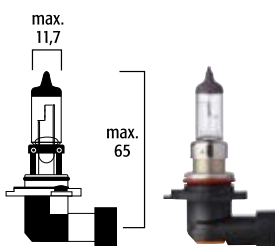



2090B	12	65	PGJY19-5	H9B gerader Sockel straight socket culot droit · base recta	10	100
-------	----	----	----------	---	----	-----



H10 Lampen · H10 Bulbs · Lampes H10 · Lámparas H10

Type	V	W		i		
9145	12	42	PY20d	H10	10	100

H11 Lampen · H11 Bulbs · Lampes H11 · Lámparas H11

Type	V	W				
21110	12	55	PGJ19-2	H11	10	100
92110	12	55	PGJ19-2	H11 Blister	1	27
21114	24	70	PGJ19-2	H11	10	100
211022	12	55	PGJ19-2	H11 Longlife	10	100
2110333	12	55	PGJ19-2	H11 Megablau · megablue	10	100
2110500	12	55	PGJ19-2	H11 Ultra White 5K 5000°K +40%	10	100
2110110	12	55	PGJ19-2	H11 Ultra White 5K 5000°K +40% Doppelbox · twinbox	1	10
2110900	12	55	PGJ19-2	H11 Ultra +90%	10	100
92110900	12	55	PGJ19-2	H11 Ultra +90% Blister	1	27
2110130	12	55	PGJ19-2	H11 Ultra +130%	1	100
2110260	12	55	PGJ19-2	H11 Ultra +130% Doppelbox · twinbox	1	10
2110B	12	55	PGJY19-2	H11B gerader Sockel straight socket culot droit · base recta	10	100
2110335	12	70	PGJ19-2	H11 Silberblau · silverblue	10	100
12110	12	90	PGJ19-2	H11 Rally	10	100

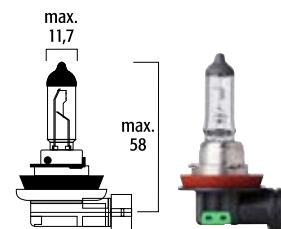



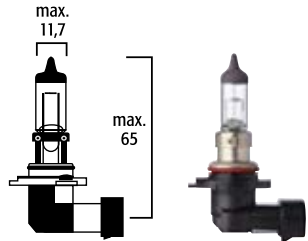

H12 Lampen · H12 Bulbs · Lampes H12 · Lámparas H12

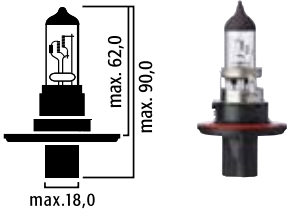

Type	V	W		i		
9055	12	53	PZ20d	H12	10	100



H13 Lampen · H13 Bulbs · Lampes H13 · Lámparas H13

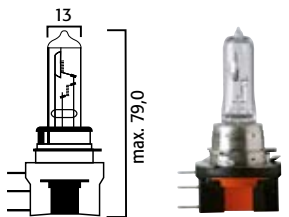

Type	V	W		i		
9008	12	60/55	P26,4t	H13	10	100
9108	12	100/80	P26,4t	H13 Rally	10	100

H15 Lampen · H15 Bulbs · Lampes H15 · Lámparas H15



Type	V	W		i		
551523	12	55/15	PGJ23t-1	H15	10	100
602023	24	60/20	PGJ23t-1	H15	10	100

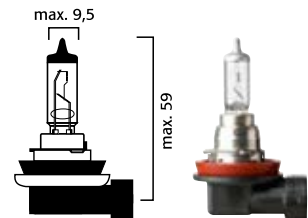

H16 Lampen · H16 Bulbs · Lampes H16 · Lámparas H16

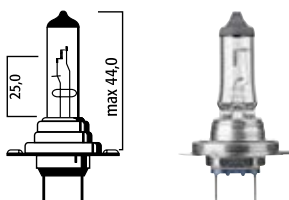

Type	V	W		i		
191219	12	19	PGJ19-3	H16 Longlife	10	100

H18 Lampen · H18 Bulbs · Lampes H18 · Lámparas H18



Type	V	W		i		
2180	12	65	PY26d-1	H18 Longlife	10	100

H19 Lampen · H19 Bulbs · Lampes H19 · Lámparas H19

Type	V	W		i		
6255PU43	12	60/55	PU43t-3	H19	10	100

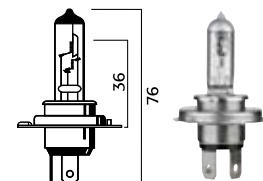

Amerikanische Typen · American types · Types américains · Tipos americanos

Type	V	W		i		
9004	12	65/45	P29t	HB1	10	100
99004	12	65/45	P29t	HB1 Blister	1	21

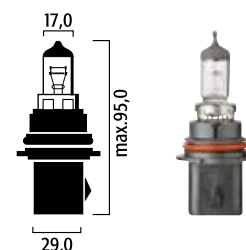

9004333	12	65/45	P29t	HB1 Blau · blue	10	100
---------	----	-------	------	-----------------	----	-----



9004777	12	65/45	P29t	HB1 Gold	10	100
---------	----	-------	------	----------	----	-----



9004100	12	65/45	P29t	HB1 Ultra +100%	10	100
---------	----	-------	------	-----------------	----	-----



9104	12	100/80	P29t	HB1 Rally	10	100
------	----	--------	------	-----------	----	-----



9104333	12	100/80	P29t	HB1 Rally Blau · blue	10	100
---------	----	--------	------	-----------------------	----	-----







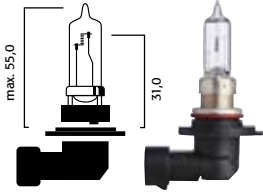

Halogen Scheinwerferlampen mit Kunststoffsockel · Halogen headlight bulbs with plastic base
Lampes phares halogènes avec culot plastique · Bombillas halógenas con base de plástico para faros



HB3 Lampen · HB3 Bulbs · Lampes HB3 · Lámparas HB3

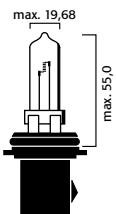

Type	V	W				
9005	12	60	P20d	HB3	10	100
99005	12	60	P20d	HB3 Blister	1	24
9005333	12	60	P20d	HB3 Megablau megablue	10	100
9005900	12	60	P20d	HB3 Ultra +90%	10	100
99005900	12	60	P20d	HB3 Ultra +90% Blister	1	24
9105	12	100	P20d	HB3 Rally	10	100
9005XS	12	60	PX20d	HB3A gerader Sockel straight socket culot droit · base recta	10	120



HB4 Lampen · HB4 Bulbs · Lampes HB4 · Lámparas HB4

Type	V	W		i		
9006	12	51	P22d	HB4	10	100
99006	12	51	P22d	HB4 Blister	1	24
9006333	12	51	P22d	HB4 Megablau megablue	10	100
9006900	12	51	P22d	HB4 Ultra +90%	10	100
99006900	12	51	P22d	HB4 Ultra +90% Blister	1	24
9076	12	70	P22d	HB4 Rally	10	100
9086	12	80	P22d	HB4 Super Rally	10	100
9006335	12	60	P22d	HB4 Silberblau · silverblue	10	100
9006XS	12	51	P22d	HB4 gerader Sockel straight socket culot droit · base recta	10	120

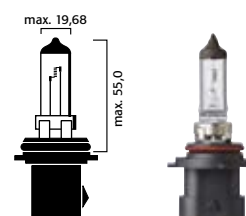
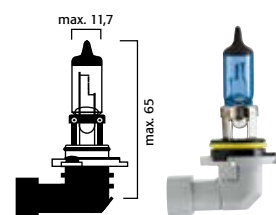
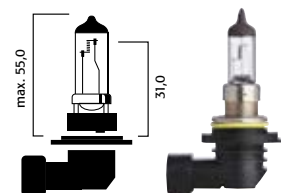

HB5 Lampen · HB5 Bulbs · Lampes HB5 · Lámparas HB5

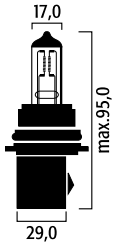

Type	V	W		i		
9007	12	65/55	PX29t	HB5	10	100
99007	12	65/55	PX29t	HB5 Blister	1	21
9007333	12	65/55	PX29t	HB5 Blau · blue	10	100
9107	12	100/80	PX29t	HB5 Rally	10	100





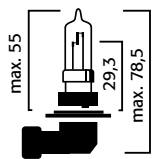

HIR Lampen · HIR Bulbs · Lampes HIR · Lámparas HIR

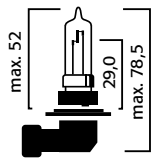

Type	V	W		i		
9011	12	65	PX20d	HIR1 Halogen Infrarot · infrared	10	100
9012	12	55	PX22d	HIR2 Halogen Infrarot · infrared	10	100



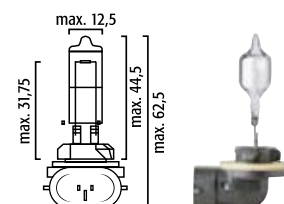
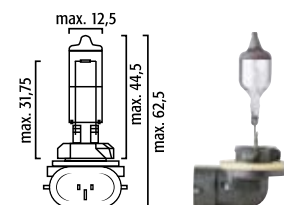
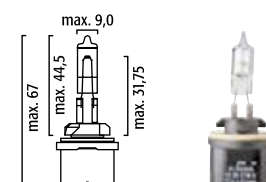
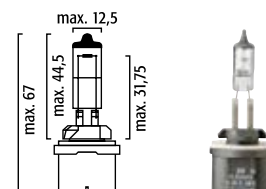
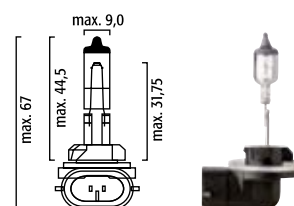
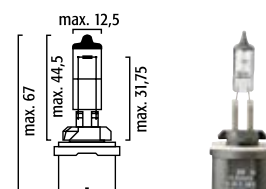

H27W Lampen · H27W Bulbs · Lampes H27W · Lámparas H27W

Type	V	W				
880	12	27	PG13	H27W/1	10	100
881	12	27	PGJ13	H27W/2	10	100
893	12	37,5	PG13		10	100
885	12	50	PG13	Keine schwarze Kappe no black cap	10	100
890	12	27	PG13	Keine schwarze Kappe no black cap	10	100
896	12	37,5	PGJ13		10	100
886	12	50	PGJ13	Keine schwarze Kappe no black cap	10	100
894	12	37,5	PGJ13	Keine schwarze Kappe no black cap	10	100

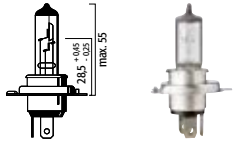



Type	V	W		i		
323543	12	35/35	PX43t	HS1	10	100
3235333	12	35/35	PX43t	HS1 blau · blue	10	100
323023	12	35/30	P23t	HS5	10	100
392380	12	25/25	BA20d	Halogen	10	200
393980	12	35/35	BA20d	S2 Halogen	10	200
39398033	12	35/35	BA20d	Halogen Blau · blue	10	200

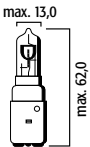
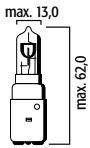
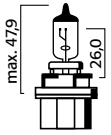





Halogenlampen für Zweiräder · Halogen bulbs for two-wheelers
Lampes halogènes pour deux-roues · Bombillas halógenas para motos

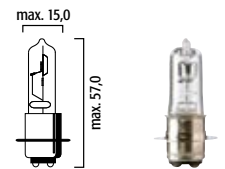
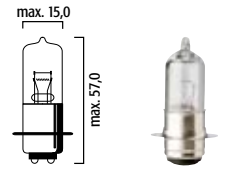

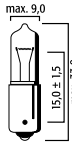
Type	V	W		i		
2251	12	25/25	P15d-25-1	M5	10	100
2351	12	35/35	P15d-25-1	M5	10	100
2353	12	35/35	P15d-25-3	M5	10	100
225112	12	25/25	P15d-25-1	M5 mit Abblendkappe with cap	10	100
235112	12	35/35	P15d-25-1	M5 mit Abblendkappe with cap	10	100
235312	12	35/35	P15d-15-3	M5 mit Abblendkappe with cap	10	200





Type	V	W		i		
4005	12	5	BA9s		10	200
4010	12	10	BA9s		10	200
4020	12	20	BA9s		10	200
4006	12	6	BAX9s	H6W	10	200
400633	12	6	BAX9s	H6W Blau · blue	10	200
400601	12	6	BAZ9s	HY6W Amber	10	200
6021	12	21	BAY9s	H21W	10	200
602101	12	21	BAW9s	HY21W · Amber	10	200
6421	24	21	BAY9s	H21W	10	200

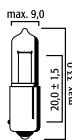
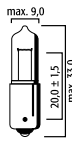
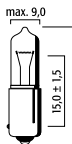
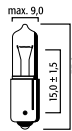

Miniaturchalogenlampen · Miniature halogen bulbs
Lampes halogènes miniatures · Bombillas halógenas miniatura



Type	V	W		i		
4891	12	5	W2,1x9,5d	W5W	10	200
489133	12	5	W2,1x9,5d	W5W Blau · blue	10	100
2074210	12	10	G4		10	100
2074220	12	20	G4		10	100
2074410	24	10	G4		10	100
2074420	24	20	G4		10	100
795X	12	50	BA15s	Halogen	10	100

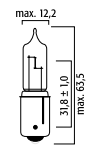
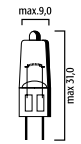
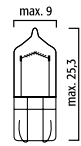

Scheinwerferlampen · Headlight bulbs · Lampes phares · Bombillas para faros

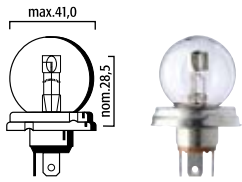

Type	V	W		i		
3130	6	45/40	P45t	R2	10	100
3940	12	45/40	P45t	R2	10	100
3770	24	55/50	P45t	R2	10	100
394002	12	75/75 CP	P45t		10	100
377002	24	75/75 CP	P45t		10	100

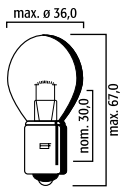

3329	12	35	BA20s	F2	10	200
3350	12	50	BA20s		10	200
3440	24	35	BA20s	F2	10	200

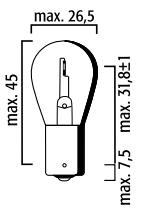

6640	24	45	BA15s	Form U	10	200
------	----	----	-------	--------	----	-----

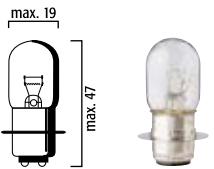

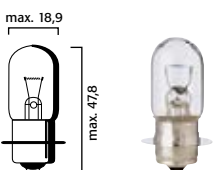

6251	6	25/25	P15d-25-1		10	100
1181	12	18/18	P15d-25-1		10	100
1251	12	25/25	P15d-25-1		10	100



1351	12	35/35	P15d-25-1		10	100
1151	12	25	P15s-25-1		10	100

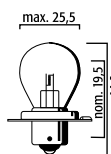
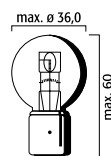
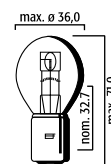

Scheinwerferlampen für Zweiräder · Headlight bulbs for two-wheelers
Lampes phares pour deux-roues · Bombillas para faros para motos

Type	V	W		i		
3265	6	15/15	BA20d		10	200
3223	6	25/25	BA20d	S1	10	200
3131	6	35/35	BA20d	S2	10	200
3923	12	25/25	BA20d	S1	10	200
3939	12	35/35	BA20d	S2	10	200
93939	12	35/35	BA20d	S2 Blister	1	8
24540	12	45/40	BA20d		10	200
6743	24	45/40	BA20d		10	200
5775	6	45/40	BA21d		10	200
6776	12	45/40	BA21d		10	200
6000	6	15	P26s	S3	10	100
2000	12	15	P26s	S3	10	100
200033	12	15	P26s	Blau · blue	10	100
4000	24	15	P26s		10	100
2001	12	20	P26s		10	100
2002	12	25	P26s		10	100

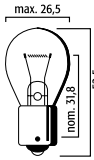

Stopp- und Blinklampen · Stop and flashing lights
Lampes stop et clignotantes · Bombillas stop e intermitente



Type	V	W		i		
6670	6	21	BA15s	P21W	10	200
6671	12	21	BA15s	P21W 1141	10	200
96671	12	21	BA15s	P21W Blister	1	33
6652	24	21	BA15s	P21W	10	200
665299	24	21	BA15s	P21W Heavy Duty	10	200



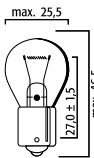

Type	V	W		i		
667107	12	21	BA15s	Amber	10	200
667133	12	21	BA15s	Blau · blue	10	200
665207	24	21	BA15s	Amber	10	200
8671	12	25	BA15s	1073	10	200
8652	24	25	BA15s		10	200
9671	48	25	BA15s		10	200





5671	12	15	BA15s	93	10	200
4670	6	18	BA15s		10	200
4671	12	18	BA15s		10	200
4652	24	18	BA15s		10	200

Stopp- und Blinklampen · Stop and flashing lights
Lampes stop et clignotantes · Bombillas stop e intermitente

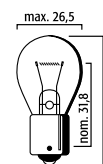
Type	V	W		i		
667101	12	21	BAU15s	PY21W Amber	10	200
9667101	12	21	BAU15s	PY21W Amber Blister	1	33
6671SV	12	21	BAU15s	PY21W Silber · silver	10	200
665201	24	21	BAU15s	PY21W Amber	10	200



Type	V	W		i		
6678	12	21	BAU15s	Klar · clear	10	200

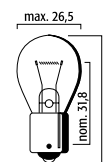

Type	V	W		i		
6674	12	21	BA15d	1142	10	200

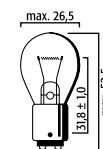

Type	V	W		i		
667102	12	21	BAW15s	PR21W Rot · red	10	200

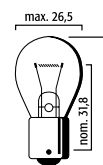

Type	V	W		i		
3156	12	27	W2,5x16d	P27W	10	500
93156	12	27	W2,5x16d	P27W Blister	1	33
315601	12	27	W2,5x16d	Amber	10	500

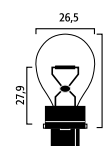

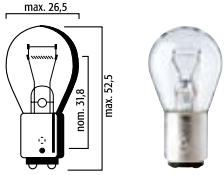

Stopp- und Rücklichtlampen · Stop and taillamp bulbs
Lampes stop et arrières · Bombillas stop y luz trasera

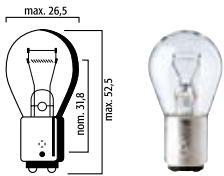

Type	V	W		i		
5228	6	21/5	BAY15d	P21/5W	1154	10 / 200
5229	12	21/5	BAY15d	P21/5W	1016	10 / 200
95229	12	21/5	BAY15d	P21/5W Blister	1	33
5239	24	21/5	BAY15d	P21/5W	10	200







Type	V	W		i		
5226	6	10/3	BAY15d		10	200
5227	12	10/5	BAY15d		10	200
5230	12	32/4 CP	BAY15d	1034	10	200
5209	12	18/5	BAY15d		10	200
9629	48	25/10	BAY15d		10	200
522907	12	21/5	BAY15d	Amber	10	200

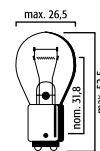

Stopp- und Rücklichtlampen · Stop and taillamp bulbs
Lampes stop et arrières · Bombillas stop y luz trasera

Type	V	W		i		
5219	12	21/5	BA15d	1176	10	200



Type	V	W		i		
522902	12	21/5	BAW15d	PR21/5W Rot · red	10	200

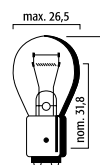

Type	V	W		i		
5329	12	21/4	BAZ15d	P21/4W	10	200
5339	24	21/4	BAZ15d	P21/4W	10	200

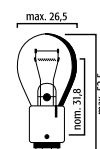

Type	V	W		i		
3157	12	27/7	W2,5x16q	P27/7W	10	500
93157	12	27/7	W2,5x16q	P27/7W Blister	1	33
315701	12	27/7	WX2,5x16q	PY27/7W 3157NA	10	500
3057	12,8	32/2 CP	W2,5x16q		10	500
375701	12,8	2,1/0,59 A	WX2,5x16q	3757NA	10	500

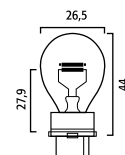

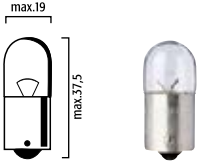

Kugellampen · Taillamp bulbs · Graisseur · Bombillas de posición

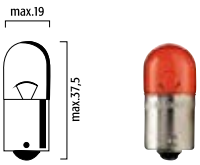

Type	V	W		i			
4023	6	5	BA15s	R5W	10	200	
4025	12	5	BA15s	R5W	67	10	200
94025	12	5	BA15s	R5W Blister	1	51	
4052	24	5	BA15s	R5W	10	200	
405299	24	5	BA15s	R5W Heavy Duty	10	200	



Type	V	W		i		
402509	12	5	BA15s	Rot · red	10	200



405233	24	5	BA15s	Blau · blue	10	200
--------	----	---	-------	-------------	----	-----

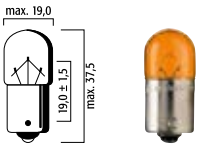

1402507	12	10	BA15s	Amber	10	200
---------	----	----	-------	-------	----	-----



1402533	12	10	BA15s	Blau · blue	10	200
---------	----	----	-------	-------------	----	-----

Kugellampen · Taillamp bulbs · Graisseurs · Bombillas de posición

Type	V	W		i		
14023	6	10	BA15s	R10W	10	200
14025	12	10	BA15s	R10W	10	200
914025	12	10	BA15s	R10W Blister	1	51
14052	24	10	BA15s	R10W	10	200
1405299	24	10	BA15s	R10W Heavy Duty	10	200

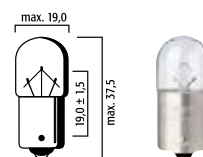

Type	V	W		i		
1402501	12	10	BAU 15s	RY10W Amber	10	200
91402501	12	10	BAU 15s	RY10W Amber Blister	1	10

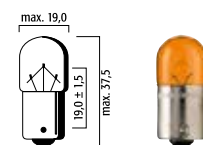

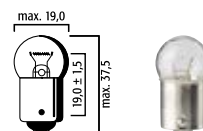

Type	V	W		i		
1421	12	3	BA15s		10	100
15025	12	15	BA15s		10	100
4071	12	21	BA15s		10	100

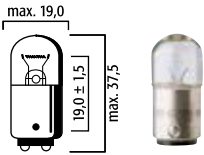

Anzeigelampen · Indicator light bulbs · Lampes témoins · Bombillas auxiliares



Type	V	W		i		
4425	12	5	BA15d	R5W	10	200
4452	24	5	BA15d	R5W	10	200
14425	12	10	BA15d	R10W	10	100
14452	24	10	BA15d	R10W	10	100

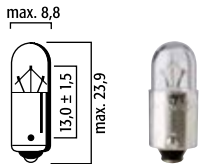

Type	V	W		i		
4039	6	2	BA9s		10	100
4038	12	2	BA9s	53	10	200
3038	12	3	BA9s		10	200
4008	24	2	BA9s		10	200
3008	24	3	BA9s		10	200

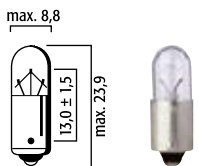

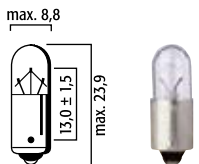

Type	V	W		i		
4089	6	4	BA9s	T4W	10	200
4088	12	4	BA9s	T4W	10	200
94088	12	4	BA9s	T4W Blister	1	75



4080	24	4	BA9s	T4W	10	200
408099	24	4	BA9s	T4W Heavy Duty	10	200

Mit Sockel BA9s · With base BA9s · Avec culot BA9s · Con base BA9s

Type	V	W		i		
2038	12	4	BA9s	57	10	200
408835	12	4	BA9s	Dunkelblau · dark blue	10	100
408035	24	4	BA9s	Dunkelblau · dark blue	10	100
4085	12	5	BA9s		10	100

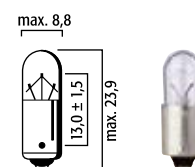
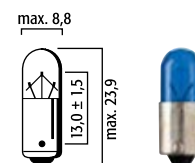
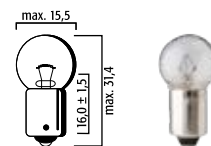

Mit Sockel BA7s · With base BA7s · Avec culot BA7s · Con base BA7s

Type	V	W		i		
4049	6	0,6	BA7s		10	100
4050	6	1,2	BA7s		10	200
4051	12	2	BA7s		10	200
4048	24	3	BA7s		10	200

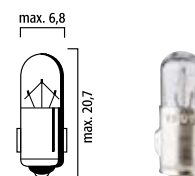



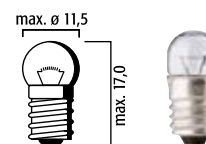

Mit Schraubsockel · With screw base · Avec culot vissé · Con base rosca

Type	V	W		i		
4043	6	2	E10		25	500
4045	12	3	E10		10	100
4046	24	3	E10		10	100

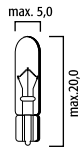

Mit Glassockel · With glass base · Avec culot verre · Con base de vidrio





Type	V	W		i			
4196	6	1,2	W2x4,6d	W1,2W	10	100	
4191	12	1,2	W2x4,6d	W1,2W	74	10	200
94191	12	1,2	W2x4,6d	T5 Blister	1	75	
419122	12	1,2	W2x4,6d	T5 Longlife	10	100	
419106	12	1,2	W2x4,6d	T5 Matt · frosted	10	100	
4391	12	2	W2x4,6d		10	100	
4691	12	2,3	W2x4,6d	W2,3W	10	100	
469101	12	2,3	W2x4,6d	WY2,3W Amber	10	100	

Mit Glassockel · With glass base · Avec culot verre · Con base de vidrio

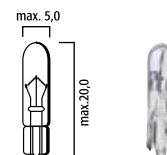
Type	V	W		i		
4590	12	3	W2x4,6d		10	100
4192	24	1,2	W2x4,6d	W1,2W	10	200
27140	24	30 mA	W2x4,6d	T5	10	100
27141	24	1	W2x4,6d	T5	10	100



Type	V	W		i		
4591	12	3	W2x4,6d		10	100

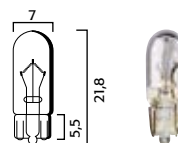

Type	V	W		i			
4090	12	3	W2,1x9,5d	W3W T10	158	10	200
4092	24	3	W2,1x9,5d	W3W T10	10	200	

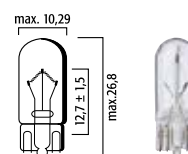

4291	12	5	W2,1x9,5d	W5W T10	10	200
94291	12	5	W2,1x9,5d	W5W T10 Blister	1	75
429122	12	5	W2,1x9,5d	W5W T10 Longlife	10	200
429133	12	5	W2,1x9,5d	W5W T10 Blau · blue	10	100
4292	24	5	W2,1x9,5d	W5W T10	10	200
429101	12	5	W2,1x9,5d	WY5W T10 Amber	10	100

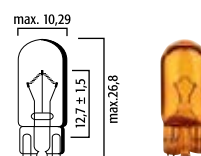
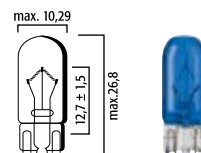

Mit Glassockel · With glass base · Avec culot verre · Con base de vidrio

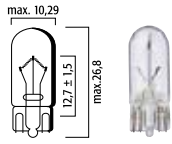

Type	V	W		i		
4290	12	2	W2,1x9,5d	W2W T10	10	200
4096	6	3	W2,1x9,5d	W3W T10	10	100
429235	24	5	W2,1x9,5d	T10 Dunkelblau · dark blue	10	100

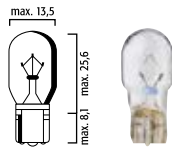

Type	V	W		i		
4496	6	10	W2,1x9,5d		10	100
4490	12	10	W2,1x9,5d		10	100
449007	12	10	W2,1x9,5d	T13 Amber	10	100



Mit Glassockel · With glass base · Avec culot verre · Con base de vidrio

Type	V	W		i		
921	12	16	W2,1x9,5d	W16W T15	10	200
9921	12	16	W2,1x9,5d	W16W T15 Blister	1	51
92107	12	16	W2,1x9,5d	WY16W Amber	10	100

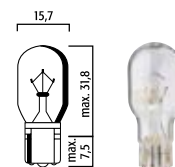

Type	V	W		i		
2190	12	21	W3x16d	W21W T20	10	700
92190	12	21	W3x16d	W21W T20 Blister	1	10
219007	12	21	WX3x16d	WY21W Amber T20	10	700

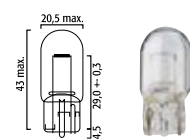

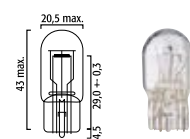

2690	12	21/5	W3x16q	W21/5W T20	10	700
92690	12	21/5	W3x16q	W21/5W T20 Blister	1	10
269007	12	21/5	W3x16q	Amber T20	10	700

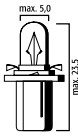

Mit Kunststoffsockel · With plastic base · Avec culot plastique · Con base de plástico



Type	V	W		i		
419101	12	1,2	B8,5d	Schwarz · black	10	50
449101	12	1,2	BX8,5d	Hellblau · light blue	10	100
459101	12	1,5	BX8,5d	Gelb · yellow	10	100
439101	12	2	B8,5d	Grün · green	10	100
479101	12	2	BX8,5d	Weißgrün · white green	10	100
419201	24	1,2	B8,5d	Grau · grey	10	100
419301	24	1,2	BX8,5d	Braun · brown	10	100

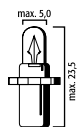



Type	V	W		i		
419102	12	1,2	B8,3d	Schwarz · black	10	100
439102	12	2	B8,3d	Weiß · white	10	100
419202	24	1,2	B8,3d	Grau · grey	10	100

Mit Kunststoffsockel · With plastic base · Avec culot plastique · Con base de plástico

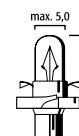
Type	V	W		i		
419103	12	1,2	BX8,4d	Schwarz · black	10	100
449103	12	1,1	BX8,4d	Orange	10	100
479103	12	1,3	BX8,4d	Olivgrün · olive green	10	100
459103	12	1,5	BX8,4d	Beige	10	100
439103	12	2	BX8,4d	Grün · green	10	100



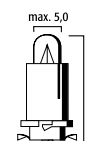
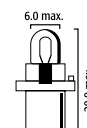

Type	V	W		i		
188328	24	1,2	EBS N10	Beige	10	100
183385	12	1,8	EBS R11	Blau · blue	10	100
181471	24	1,2	EBS R6	Braun · brown	10	100
181791	24	1,2	EBS R4	Gelb · yellow	10	100
183527	24	1,2	EBS R10	Matt · frosted Weiß · white	10	100

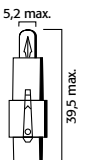
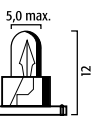
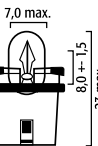
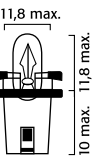
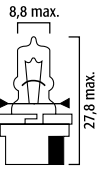
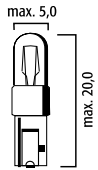
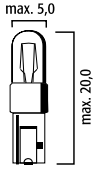

Mit Kunststoffsockel · With plastic base · Avec culot plastique · Con base de plástico





Type	V	W		i		
6924	12	0,5	W2x4,6d	PVC Grau · grey	10	100
6925	12	1,2	W2x4,6d	PVC Weiß · white	10	100
6441	24	1	W2x4,6d	PVC Weiß · white	10	100

Type	V	W		i		
409080	12	3	B10d	Halogen	10	100
429180	12	5	B10d	Halogen	10	100

Type	V	W		i		
419104	12	1,2	B8,7d	Grau · grey	10	100
439104	14	1 CP	B11d-T7	Rosa · pink	10	100
449105	14	1,4	HRQ	Schwarz · black	10	100
181649	12	1,2	SG8-5,5d	Schwarz · black	10	100

Soffitten · Festoons · Navettes · Tubulares

Type	V	W		i		
6127	6	1	SV5,5 6x24 mm		10	100
6158	12	3	SV5,5 6,3x36 mm		10	100
6159	24	3	SV5,5 6,3x36 mm		10	100
5148	12	3	SV5,5 6,2x28 mm		10	100
5149	24	3	SV5,5 6,2x28 mm		10	100
5157	6	3	SV7 8x28 mm		10	100
5158	12	3	SV7 8x28 mm		10	100
5159	24	3	SV7 8x28 mm		10	100

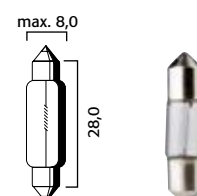
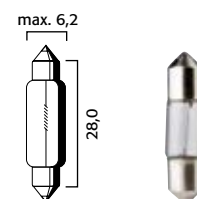
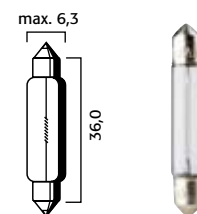
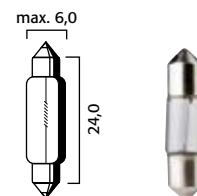

Soffitten · Festoons · Navettes · Tubulares

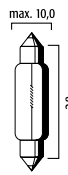

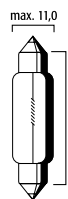

Type	V	W		i		
5168	12	10	SV8,5 10x28 mm		10	100
516835	12	10	SV8,5 10x28 mm	Dunkelblau · dark blue	10	100



Type	V	W		i		
4032	6	5	SV8,5 11x35 mm	C5W	10	100
4033	12	5	SV8,5 11x35 mm	C5W	10	200
94033	12	5	SV8,5 11x35 mm	C5W Blister	1	75
4002	24	5	SV8,5 11x35 mm	C5W	10	200

Soffitten · Festoons · Navettes · Tubulares

Type	V	W		i		
403310	12	10	SV8,5 11x35mm		10	100
400210	24	10	SV8,5 11x35mm		10	100
403333	12	5	SV8,5 11x35mm	Blau · blue	10	100
403334	12	5	SV8,5 11x35mm	Grün · green	10	100
400233	24	5	SV8,5 11x35mm	Blau · blue	10	100

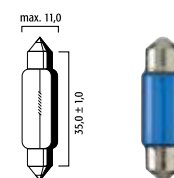
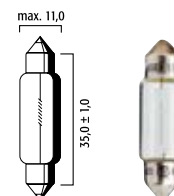

Soffitten · Festoons · Navettes · Tubulares

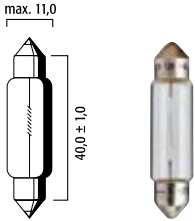

Type	V	W		i		
4230	12	5	SV8,5 11 x 40 mm		10	200
4206	24	5	SV8,5 11 x 40 mm		10	200

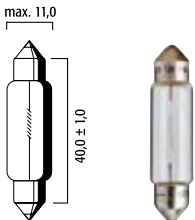

Type	V	W		i		
4203	6	10	SV8,5 11 x 40 mm		10	200
4231	12	10	SV8,5 11 x 40 mm	DIN 72601 K	10	200
94231	12		SV8,5 11 x 40 mm	DIN 72601 K Blister	1	75
4210	24	10	SV8,5 11 x 40 mm		10	200

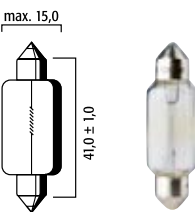

Type	V	W		i		
400115	6	15	SV8,5 15 x 41 mm		10	100
400415	12	15	SV8,5 15 x 41 mm		10	200
4215	24	15	SV8,5 15 x 41 mm		10	200

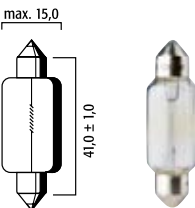



400118	6	18	SV8,5 15 x 41 mm		10	100
400418	12	18	SV8,5 15 x 41 mm		10	200
4218	24	18	SV8,5 15 x 41 mm		10	200
400421	12	21	SV8,5 15 x 41 mm	C21W	10	100

Soffitten · Festoons · Navettes · Tubulares

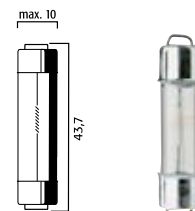
Type	V	W		i		
211-2	12,8	12 CP	Miniature Cap		10	200





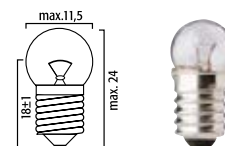
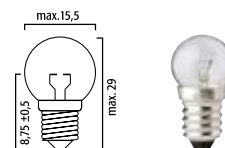
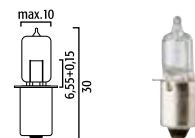

Fahrradlampen · Bicycle lamps
Lampes pour bicyclettes · Bombillas para bicicletas

Type	V	W		i		
6024	6	2,4	PX13,5s	HS3, Halogen	10	200
624	6	2,4	E10	C2,4W	10	100
660	6	6,0	E10		10	100
606	6	0,6	E10	C0,6W	10	100

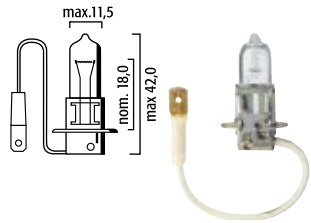

High Voltage



Type	V	W		i		
3348	48	45	PK22s	H3	10	100
3380	80	55	PK22s	H3	10	100

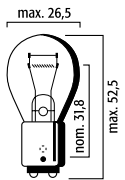

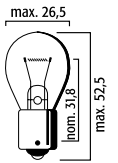

9629	48	25/10	BAY15d		10	200
------	----	-------	--------	--	----	-----



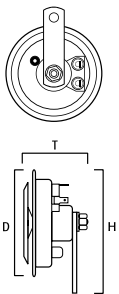

9671	48	25	BA15s		10	200
------	----	----	-------	--	----	-----





Type	V	i		
483359	48	91 mm disc horn, 340 Hz D = 90 mm +/-1 T = 56 mm +/-1 H = 115 mm	1	26

High Voltage

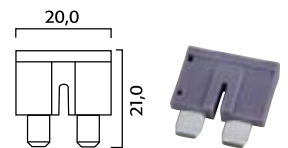
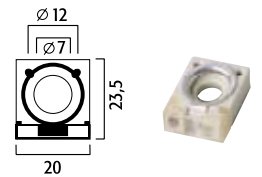
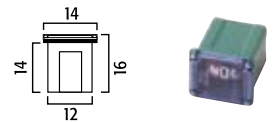
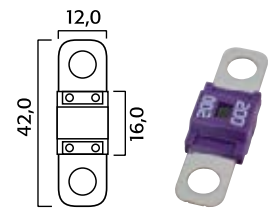
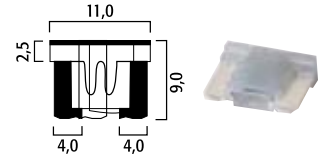
Type	V	A	i		
5038xx	58	2 - 30	Farbkodiert · color coded	50	500
7048xxx	58	30 - 200	Farbkodiert · color coded	10	100
6089xx	58	20 - 60	Farbkodiert · color coded	10	100
9048xxx	58	50 - 300		10	100
2848xx	80	1 - 40	Farbkodiert · color coded	10	500



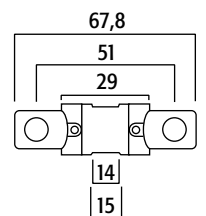

Type	V	A	i		
8058xx	70	80 - 500	Farbkodiert · color coded	10	50

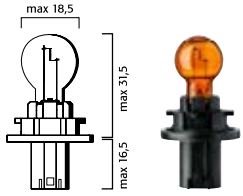



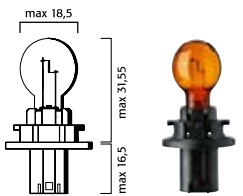
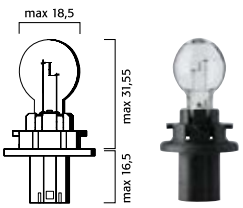
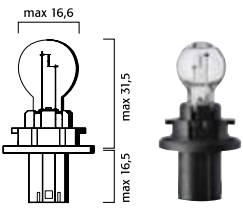



Type	V	W		i		
38965433	12	16	PU20d/2	HPC16WY Amber	1	10
77715934	12	16	PU20d/1	HPC16W	1	10
77715941	12	19	PU20d/3	HPC19W	1	10
77715958	12	24	PU20d/6	HPC24WY Amber	1	10

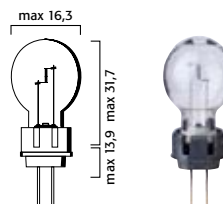
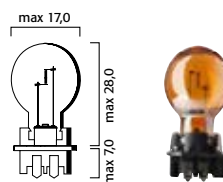
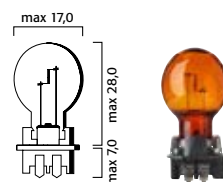
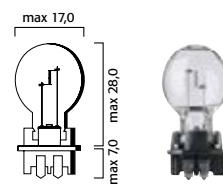
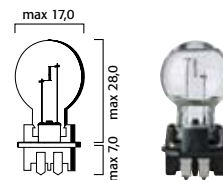

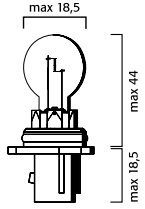
Type	V	W		i		
39623230	12	16	WP3,3x14,5/4	PW16W	1	10
39196133	12	24	WP3,3x14,5/3	PW24W	1	10
39202933	12	24	WP3,3x14,5/4	PWY24W Amber	1	10
39200533	12	24	WP3,3x14,5/4	PWY24W SV	1	10
39621860	13,5	24	Hiper LCP HTR HPSL2A		1	10





Type	V	W		i		
38874933	12	26	PG18.5d-3	PSX26W	1	10
52735233	12	19	PG20/2	PSY19W Amber	1	10
69653033	12	19	PG20/1	PS19W	1	10
69668433	12	24	PG20/4	PSY24W Amber	1	10
69672133	12	13	PG18.5-d1	P13W	1	10

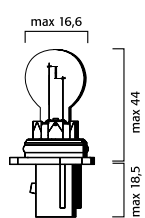
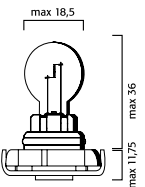
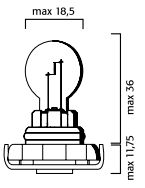
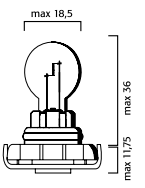



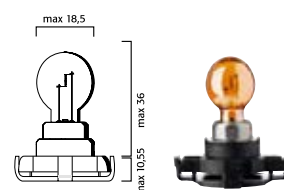
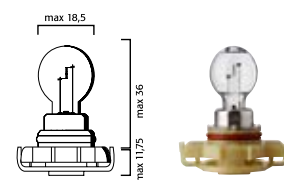
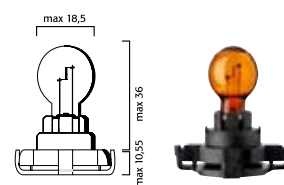
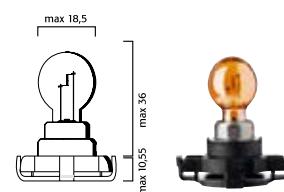
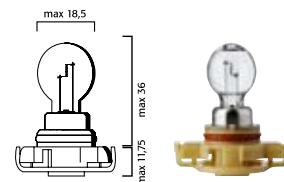

Type	V	W		i		
69676933	12	24	PG20/7	PSX24W	1	10
69678333	12	24	PGU20/4	PY24W SV	1	10
69690533	12	24	PGU20/4	PY24W Amber	1	10
70044233	12	24	PG20/3	PS24W FF	1	10
70379533	12	24	PG20/4	PSY24W SV+	1	10





Mega Lampen +50% · Mega Lamps +50%
Lampes Mega +50% · Bombillas Mega +50%

+50%

Type	V	W		i		
3021890	12	55	P14,5s	H1 +50%	10	100
2070890	12	55	PX26d	H7 +50%	10	100
6289043	12	60/55	P43t	H4 Mega +50%	10	100

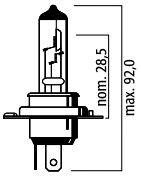
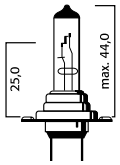
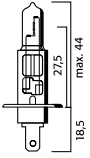

İ

Die Megalampen +50% geben 50% mehr Licht als die Standardlampen, sind aber legal zum Gebrauch im Straßenverkehr mit E1-Zeichen.

Megalamps +50% give up to 50% more light than the standart bulbs, but they are legal to use in public traffic with E1-sign.

Les ampoules Mega +50% produisent à peu près 50% plus de lumière que les ampoules standard, mais sont tout légales en trafic public avec signe E1.



Los bombillas Mega +50% producen aproximadamente 50% más luz que los bombillas estándar, pero son totalmente legales en para uso en carreteras públicas con signo E1.

+50% twinbox

Type	İ		
3021680	Doppelbox · twinbox 2 x 3021890 12 V 55 W P14,5s H1 Mega +50%	1	10
2070680	Doppelbox · twinbox 2 x 2070890 12 V 55 W PX26d H7 Mega +50%	1	10

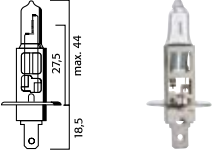
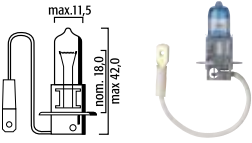
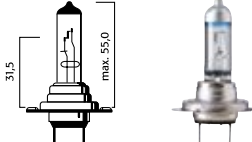
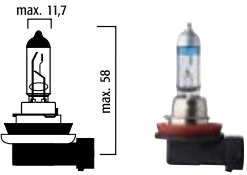
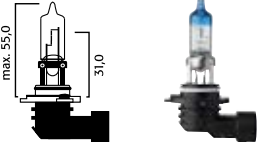
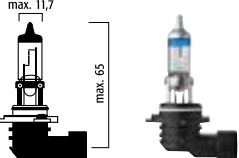
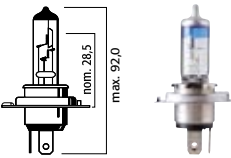
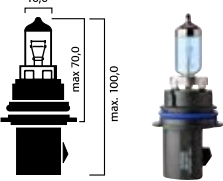

+90 % / +100%

Type	V	W		i		
	12	55	P14,5s	H1 Ultra +90%	10	100
	12	55	PK22s	H3 Ultra +90%	10	100
	12	55	PX26d	H7 Ultra +90%	10	100
	12	55	PGJ19-2	H11 Ultra +90%	10	100
	12	60	P20d	HB3 Ultra +90%	10	100
	12	51	P22d	HB4 Ultra +90%	10	100
	12	60/55	P43t	H4 Ultra +90%	10	100
	12	65/45	P29t	HB1 Ultra + 100%	10	100

i

Sicheres Fahren mit Ultra Lampen: Die FLÖSSER Ultra Lampen liefern bis zu 90% mehr Licht und eine hohe Beleuchtungsstärke. Die partielle blaue Beschichtung erzeugt ein weißeres Licht als normale Autolampen. Getestet und zugelassen im Straßenverkehr nach ECE R37 mit E1.

Safer driving with Ultra lamps: FLÖSSER Ultra lamps produce up to 90% more light and high luminosity. The partial blue coating on the glass creates a day white light. Tested and approved in public traffic according to ECE R37 with E1.

Conduire plus sur avec ampoules Ultra : Les ampoules Ultra de FLÖSSER produisent à peu près 90% plus de lumière avec haut intensité. La coloration partielle crée une lumière plus blanche que les ampoules standard. Testé et approuvé dans le trafic public selon ECE R37 avec E1.

Conducir más seguro con bombillas Ultra: Los bombillas FLÖSSER Ultra producen hasta 90% más de luz con fuerte intensidad. La coloración parcial en azul hace la luz más blanca que los bombillas estándar. Verificado y aprobado de acuerdo a la norma ECE R37 con E1.

+90% twinbox

Type	i		
3021180	Doppelbox · twinbox 2 x 3021900 12 V 55 W P14,5s H1 Ultra +90%	1	10
2070180	Doppelbox · twinbox 2 x 2070900 12 V 55 W PX26d H7 Ultra +90%	1	10
6255180	Doppelbox · twinbox 2 x 6290043 12 V 60/55 W P43t H4 Ultra +90%	1	20



+130 %

Type	V	W		i		
	12	55	P14,5s	H1 Ultra +130 %	1	100
	12	55	PX26d	H7 Ultra +130 %	1	100
	12	55	PGJ19-2	H11 Ultra +130 %	1	100
	12	60/55	P43t	H4 Ultra +130 %	1	100



İ

Die Weiterentwicklung unserer Flösser Ultra Lampen ist nun verfügbar mit +130%.
Sie bringen noch mehr Licht auf die Straße und sind selbstverständlich ebenfalls Europaweit
zugelassen nach ECE R37.
Für eine gute Fahrt mit zusätzlicher Sicherheit.

The next advancement of Flösser Ultra lamps is now available with +130%.
They bring even more onto the road and are approved for use in Europe under ECE R37 as well.
For a good trip with extra security.

Nos lampes Ultra, perfectionnées à une version +130%, sont maintenant disponibles ex stock.
Avec eux vous avez même plus lumière sur la route et, bien sûr, elles sont approuvées
en Europe selon règlement ECE R37.
Pour le bon voyage avec plus sécurité.









Nuestros bombillas Ultra, perfeccionados a una versión +130%, ahora están disponibles en almacén.
Con éstos, tendrán más luz en la ruta y, por supuesto, son aprobados en Europa de acuerdo
al reglamento ECE R37.
Para el buen viaje con más seguridad.

+130% twinbox

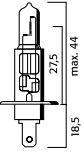
Type	İ		
3021260	Doppelbox · twinbox 2 x 3021130 12 V 55 W P14,5s H1 Ultra +130%	1	10
2070260	Doppelbox · twinbox 2 x 2070130 12 V 55 W PX26d H7 Ultra +130%	1	10
2110260	Doppelbox · twinbox 2 x 2110130 12 V 55 W PGJ19-2 H11 Ultra +130%	1	10
6255260	Doppelbox · twinbox 2 x 6213043 12 V 60/55 W P43t H4 Ultra +130%	1	20

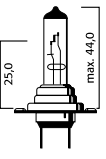

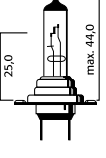
+30 % 4200°K / +40 % 5000°K

Type	V	W		i		
 	12	55	P14,5s	H1 Ultra White 5000°K +40 %	10	100
 	12	55	PX26d	H7 Ultra White 4200°K +30 %	10	100
 	12	55	PX26d	H7 Ultra White 5000°K +40 %	10	100

i

Die Lichtfarbe einer Lampe wird als Farbtemperatur in Grad Kelvin angegeben. Je größer die Zahl, desto weißer ist das Licht. FLÖSSER Ultra White Lampen haben eine Farbtemperatur von 4.200 °K – wie die üblichen Xenon Entladungslampen – und erzeugen ein helles, strahlend weißes Licht. Gleichzeitig entsprechen sie in ihrer elektrischen Leistung den Standardlampen und sind im Straßenverkehr zugelassen.

A light bulb's color temperature is given in degrees Kelvin. The higher the value, the whiter the light. FLÖSSER Ultra White bulbs feature a color temperature of 4.200 °K – comparable to Xenon HID lamps – and create a brilliantly bright white light. At the same time they retain standard wattage and are street legal.

La couleur de la lumière d'une ampoule est désignée comme température de la couleur et mesurée en degrés Kelvin. Plus la température, plus blanche est la lumière. Les ampoules FLÖSSER Ultra White ont une température de couleur de 4.200°K – comme les ampoules à décharge Xénon originales – et donc produisent une lumière blanche brillante. Au même temps les valeurs électriques sont standard et les ampoules sont tout légales.

El color de la luz de un bombilla se determina como temperatura del color y es medido en grados Kelvin. Más la temperatura, más blanca será la luz. Bombillas FLÖSSER Ultra White tienen una temperatura de luz de 4.200°K – como los bombillas de descarga Xenon usuales – y emiten una luz blanca y brillante. Al mismo tiempo los valores eléctricos son estándares y los bombillas son totalmente legales.

+30% 4200°K / +40% 5000°K twinbox

Type	i		
3021110	Doppelbox · twinbox 2 x 3021500 12 V 55 W P14,5s H1 Ultra White 5000°K +40%	1	10
2070600	Doppelbox · twinbox 2 x 2070300 12 V 55 W PX26d H7 Ultra White 4200°K +30%	1	10
2070110	Doppelbox · twinbox 2 x 2070500 12 V 55 W PX26d H7 Ultra White 5000°K +40%	1	10
2110110	Doppelbox · twinbox 2 x 2110500 12 V 55 W PGJ19-2 H11 Ultra White 5000°K +40%	1	10

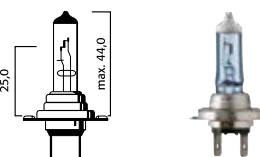

Silverblue Rally

Type	V	W		i		
	12	70	P14,5s	H1 Rally Silberblau silverblue	10	100
	12	70	PK22s	H3 Rally Silberblau silverblue	10	100
	12	70	PX26d	H7 Rally Silberblau silverblue	10	100
	12	50	PGJ19-1	H8 Rally Silberblau silverblue	10	100
	12	70	PGJ19-2	H11 Rally Silberblau silverblue	10	100
	12	60	P22d	HB4 Rally Silberblau silverblue	10	100

İ

Silberblaue FLÖSSER Lampen sind Lampen mit brillanter blauer Beschichtung und silbernen Kappen. Sie erzeugen ein strahlend weißes helles Licht von 4.300°K wie Xenon Entladungslampen.

The Silverblue FLÖSSER lamps have a shining blue coating and silver caps. They produce a brilliant white light of 4.300°K like Xenon HID.

Les ampoules de la ligne Silverblue possèdent une brillante couche bleue et une pointe d'argent. Elles produisent une lumière brillante claire avec 4.300°K comme les ampoules Xénon à décharge.

Los bombillas Silverblue tienen un recubrimiento azul brillante y un casquete plateado. Producen una luz clara blanca con 4.300°K como los bombillas Xenon de descarga.

Silverblue Rally twinbox

Type	İ		
3021670	Doppelbox · twinbox 2 x 3021335 12 V 70 W P14,5s H1 Rally Silberblau · silverblue	1	10
2070670	Doppelbox · twinbox 2 x 2070335 12 V 70 W PX26d H7 Rally Silberblau · silverblue	1	10







LED Frontscheinwerfer · LED headlights LED de phare · Faro LED

LED Set



Type	V	W		i		
91625543	12-24	26	P43t	H4 LED · 6000° K Set bestehend aus 2 Stück Set containing 2 pieces Ensemble contenant 2 pièces Set que contiene 2 piezas	1	
912070	12-24	26	PX26d	H7 LED · 6000° K Set bestehend aus 2 Stück Set containing 2 pieces Ensemble contenant 2 pièces Set que contiene 2 piezas	1	
913021	12-24	24	P14,5s	H1 LED · 6000° K Set bestehend aus 2 Stück Set containing 2 pieces Ensemble contenant 2 pièces Set que contiene 2 piezas	1	
913320	12	26	PK22s	H3 LED · 6000° K Set bestehend aus 2 Stück Set containing 2 pieces Ensemble contenant 2 pièces Set que contiene 2 piezas	1	
912110	12	26	PGJ19-2	H11 LED · 6000° K Set bestehend aus 2 Stück Set containing 2 pieces Ensemble contenant 2 pièces Set que contiene 2 piezas	1	
91191219	12	26	PGJ19-3	H16 LED · 6000° K Set bestehend aus 2 Stück Set containing 2 pieces Ensemble contenant 2 pièces Set que contiene 2 piezas	1	
919006	12	26	P22d	HB4 LED · 6000° K Set bestehend aus 2 Stück Set containing 2 pieces Ensemble contenant 2 pièces Set que contiene 2 piezas	1	
919005	12	26	P20d	HB3 LED · 6000° K Set bestehend aus 2 Stück Set containing 2 pieces Ensemble contenant 2 pièces Set que contiene 2 piezas	1	

Mini LED Set

Type	V	W		i		
91M625543	12	20	P43t	H4 Mini LED · 6000° K Set bestehend aus 2 Stück Set containing 2 pieces Ensemble contenant 2 pièces Set que contiene 2 piezas	1	
91M2070	12	20	PX26d	H7 Mini LED · 6000° K Set bestehend aus 2 Stück Set containing 2 pieces Ensemble contenant 2 pièces Set que contiene 2 piezas	1	
91M3021	12	18	P14,5s	H1 Mini LED · 6000° K Set bestehend aus 2 Stück Set containing 2 pieces Ensemble contenant 2 pièces Set que contiene 2 piezas	1	



LED CANBus adapter

Type	V	i		
H1CAN-BUS12	12	Canceller / CANBus Adapter für H1 LED Scheinwerfer Verhindert Warnsignale oder Nichterkennung Canceller / CANBus Adapter for H1 LED Prevents warnings and non-recognition	2	
H1CAN-BUS24	24	Canceller / CANBus Adapter pour phares LED H1 Empêche les avertissements et la non-reconnaissance Canceller / CANBus adaptator para faros H1 LED Previene advertencias y no reconocimiento	2	
H7CAN-BUS12	12	Canceller / CANBus Adapter für H7 LED Scheinwerfer Verhindert Warnsignale oder Nichterkennung Canceller / CANBus Adapter for H7 LED Prevents warnings and non-recognition	2	
H7CAN-BUS24	24	Canceller / CANBus Adapter pour phares LED H7 Empêche les avertissements et la non-reconnaissance Canceller / CANBus adaptator para faros H7 LED Previene advertencias y no reconocimiento	2	



LED retrofit

R5W

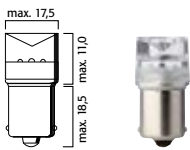
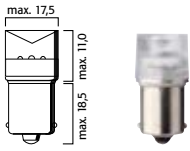

Type	V		i		
914020	12-24	BA15s 18x36 mm	R5W LED Superweiß · super white super blanc · super blanco Mattierte Abdeckung frosted cover	1	90
914028	12-24	BA15s 18x36 mm	R5W LED Rot · red · rouge · rojo Klare Abdeckung clear cover	1	90

Festoons

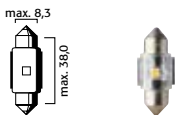
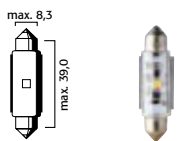
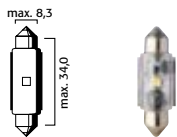
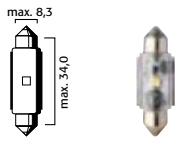

Type	V		i		
914030	12-24	SV8,5 13,5x38 mm	C5W LED Superweiß · super white super blanc · super blanco	1	180
914031	12-24	SV8,5 13,5x38 mm	C5W LED Weiß · white blanc · blanco	1	180
914231	12-24	SV8,5 13,5x44 mm	K type LED Weiß · white blanc · blanco	1	180
915168	12-24	SV8,5 13,5x31 mm	5168 type LED Weiß · white blanc · blanco	1	180

W5W

Type	V		i		
914290	12-24	W2,1x9,5d	W5W LED Superweiß · super white super blanc · super blanco Mattierte Abdeckung frosted cover Doppelbox · twinbox	1	180
914293	12-24	W2,1x9,5d	W5W LED Blau · blue · bleu · azul Klare Abdeckung clear cover Doppelbox · twinbox	1	180

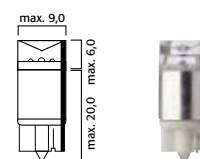

P21W

Type	V		i		
916670	12	BA15s 26,5x50mm	P21W LED Superweiß · super white super blanc · super blanco Mattierte Abdeckung frosted cover	1	90
916677	12	BA15s 26,5x50mm	P21W LED Amber Klare Abdeckung clear cover	1	90
916678	12	BA15s 26,5x50mm	P21W LED Red Klare Abdeckung clear cover	1	90
916652	24	BA15s 26,5x50mm	P21W LED Superweiß · super white super blanc · super blanco Mattierte Abdeckung frosted cover	1	90
916658	24	BA15s 26,5x50mm	P21W LED Red Klare Abdeckung clear cover	1	90

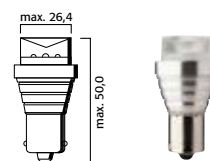

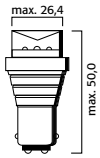

P21/5W





Type	V		i		
915220	12	BAY15d 26,5x50 mm	P21/5W LED Superweiß · super white super blanc · super blanco Mattierte Abdeckung frosted cover	1	90
915227	12	BAY15d 26,5x50 mm	P21/5W LED Amber Klare Abdeckung clear cover	1	90
915228	12	BAY15d 26,5x50 mm	P21/5W LED Red klare Abdeckung clear cover	1	90
915239	24	BAY15d 26,5x50 mm	P21/5W LED Superweiß · super white super blanc · super blanco Mattierte Abdeckung frosted cover	1	90
915238	24	BAY15d 26,5x50 mm	P21/5W LED Red Klare Abdeckung clear cover	1	90

W21W

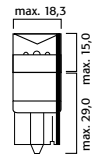
Type	V		i		
912190	12	W3x16d	W21W LED Superweiß · super white super blanc · super blanco Mattierte Abdeckung frosted cover	1	90
912197	12	WX3x16d 26,5x50mm	WY21W LED Amber Klare Abdeckung clear cover	1	90
912198	12	W3x16d	W21W LED Red Klare Abdeckung clear cover	1	90



W21/5W

Type	V		i		
912690	12	W3x16q 26,5x50mm	W21/5W LED Superweiß · super white super blanc · super blanco Mattierte Abdeckung frosted cover	1	90
912697	12	W3x16q 26,5x50mm	W21/5W LED Amber Klare Abdeckung clear cover	1	90
912698	12	W3x16q 26,5x50mm	W21/5W LED Red Klare Abdeckung clear cover	1	90

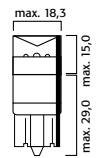



Type	i
9625543 9725543	H4 H4 Rally
96290043	H4 Ultra +90%



Type	i
93320	H3
93320900	H3 Ultra +90%



93021	H1
93021900	H1 Ultra +90%



92070	H7
92070900	H7 Ultra +90%



Type	İ
92080	H8
92090	H9
92110	H11
92110900	H11 Ultra +90%



Type	İ
99005	HB3
99005900	HB3 Ultra +90%
99006	HB4
99006900	HB4 Ultra +90%





Type	i
96671	P21W



Type	i
92190	T20 W21W



95229	P21/5W
-------	--------



92690	T20 W21/5W
-------	------------



9667101	PY21W
---------	-------



94025	R5W
-------	-----



93156	P27W
-------	------



914025	R10W
--------	------



93157	P27/7W
-------	--------



91402501	RY10W
----------	-------

Type	İ
9921	W16W
94088	T4W
94291	W5W
94191	W1,2W
94033	C5W



Type	İ
94231	Form K
93939	S2
99004	HB1
99007	HB5







Sicherungen

Fuses

Fusibles

Fusibles



Germany





Ein Wort über Sicherungen

Manchmal sind es die kleinen Dinge, die wichtig sind. Fahrzeugsicherungen zum Beispiel.

Sie schützen Ihr Fahrzeug gegen Schäden durch Kurzschluss oder überhöhten Stromdurchgang, also etwa gegen Kabel- oder Motorbrand. Unsere Sicherungen sind von erstklassiger Qualität mit einem Körper aus selbst löschendem Kunststoffmaterial und Zinkkontakten. Ein Einsatz von wenigen Cent zum Schutz Ihres wertvollen Fahrzeugs!

A word on fuses

Sometimes it's the small things that are important. Car fuses, for example. They protect your car and its cable harnesses against damage caused by short circuits or excess currents; thus against cable or engine fire. Our fuses are of first class quality: a body made of self-extinguishing plastic and zinc contacts. So only a few cents to protect your precious car!

A propos de fusibles

Parfois des choses de petite taille ont leur importance. Les fusibles de votre véhicule, par exemple.

Ils protègent l'ensemble de votre automobile contre des dommages causés soit par des court-circuits ou de courant trop élevé qui peuvent induire un incendie du véhicule. Nos fusibles sont de qualité supérieure, composés de matière plastique avec auto-extinction et de contacts de pur zinc. Un investissement de quelques centimes pour protéger le bien précieux qu'est votre automobile!

Una palabra sobre fusibles

Algunas veces las cosas pequeñas son las que más importan. Un ejemplo son los fusibles de su carro.

Protegen su auto contra daños por causa de cortocircuitos y sobrecorriente y así contra quemaduras de cables y del motor. Nuestros fusibles son de primerísima calidad con cuerpo de materia plástica auto extingible y contactos de puro zinc. Una inversión de peñiques para el cuidado de su valioso auto!

Stecksicherungen · Blade fuses · Fusibles plats · Fusibles de enchufe

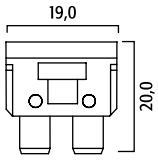

Type	V	A	i		
214801	32	1	Schwarz · black	50	4000
214802	32	2	Grau · grey	50	4000
214803	32	3	Violett · violet	50	4000
214804	32	4	Rosa · pink	50	4000
214805	32	5	Hellbraun · light brown	50	4000
214875	32	7,5	Braun · brown	50	4000
214810	32	10	Rot · red	50	4000
214815	32	15	Hellblau · light blue	50	4000
214820	32	20	Gelb · yellow	50	4000
214825	32	25	Weiß · white	50	4000
214830	32	30	Hellgrün · light green	50	4000
214835	32	35	Dunkelgrün · dark green	50	4000
214840	32	40	Orange · orange	50	4000
214800	Blisterkarte mit · Blisterpack containing · Blister avec · Blister con 1 x 5 A, 7,5 A, 25 A & 30 A 2 x 10 A, 15 A & 20 A			1	100



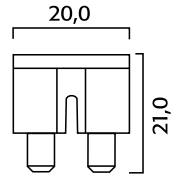

80 V Stecksicherungen · 80 V blade fuses · Fusibles plats 80 V · Fusibles de enchufe 80 V

Type	V	A	i		
284801	80	1	Schwarz · black	10	500
284802	80	2	Grau · grey	10	500
284803	80	3	Violett · violet	10	500
284804	80	4	Rosa · pink	10	500
284805	80	5	Hellbraun · light brown	10	500
284875	80	7,5	Braun · brown	10	500
284810	80	10	Rot · red	10	500
284815	80	15	Blau · blue	10	500
284820	80	20	Gelb · yellow	10	500
284825	80	25	Transparent · natural	10	500
284830	80	30	Grün · green	10	500
284840	80	40	Orange · orange	10	500

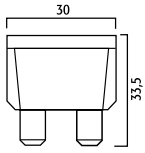

Große Stecksicherungen · Big blade fuses
Fusibles plats grands · Fusibles grandes de enchufe



Type	V	A	i		
314820	32	20	Gelb · yellow	5	400
314825	32	25	Grau · grey	5	400
314830	32	30	Grün · green	5	400
314840	32	40	Orange · orange	5	400
314850	32	50	Rot · red	5	400
314860	32	60	Hellblau · light blue	5	400
314870	32	70	Braun · brown	5	400
314880	32	80	Weiß · white	5	400
3148100	32	100	Violett · violet	5	400

Kompakte große Stecksicherungen · Big compact blade fuses
Fusibles plats grands compact · Fusibles pequeños grandes de enchufe

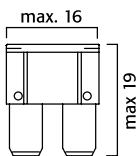

Type	V	A	i		
313820	32	20	Gelb · yellow		
313825	32	25	Weiß · white		
313830	32	30	Hellgrün · light green		
313835	32	35	Dunkelgrün · dark green		
313840	32	40	Orange · orange		
313850	32	50	Rot · red		
313860	32	60	Blau · blue		

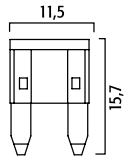

Kleine Stecksicherungen · Small blade fuses
Fusibles plats miniatures · Fusibles miniaturas de enchufe

Type	V	A	i		
514801	32	1	Schwarz · black	50	7500
514802	32	2	Grau · grey	50	7500
514803	32	3	Violett · violet	50	7500
514804	32	4	Rosa · pink	50	7500
514805	32	5	Hellbraun · light brown	50	7500
514875	32	7,5	Braun · brown	50	7500
514810	32	10	Rot · red	50	7500
514815	32	15	Hellblau · light blue	50	7500
514820	32	20	Gelb · yellow	50	7500
514825	32	25	Weiß · white	50	7500
514830	32	30	Grün · green	50	7500
514800	Blisterkarte mit · Blisterpack containing · Blister avec · Blister con 1 x 5 A, 7,5 A, 25 A & 30 A 2 x 10 A, 15 A & 20 A			1	100

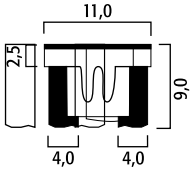

Kleine low profile Stecksicherungen · Small low profile blade fuses Fusibles plats miniatures low profile · Fusibles miniaturas de enchufe low profile



Type	V	A	i		
503802	58	2	Grau · grey	50	500
503803	58	3	Violett · violet	50	500
503804	58	4	Pink · pink	50	500
503805	58	5	Hellbraun · light brown	50	500
503875	58	7,5	Braun · brown	50	500
503810	58	10	Rot · red	50	500
503815	58	15	Hellblau · light blue	50	500
503820	58	20	Gelb · yellow	50	500
503825	58	25	Weiß · white	50	500
503830	58	30	Grün · green	50	500
513800	Blisterkarte mit · Blisterpack containing · Blister avec · Blister con 1 x 5 A, 7,5 A, 25 A, 30 A and 2 x 10 A, 15 A, 20 A.			1	100



Kleine Micro II Stecksicherungen · Small micro II blade fuses
Fusibles plats miniatures micro II · Fusibles miniaturas de enchufe micro II

Type	V	A	i		
502803	32	3	Violett · violet	50	500
502804	32	4	Rosa · pink	50	500
502805	32	5	Hellbraun · light brown	50	500
502875	32	7,5	Braun · brown	50	500
502810	32	10	Rot · red	50	500
502815	32	15	Hellblau · light blue	50	500
502820	32	20	Gelb · yellow	50	500
502825	32	25	Weiß · white	50	500
502830	32	30	Grün · green	50	500

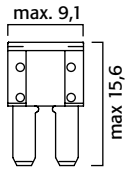

Kleine Micro III Stecksicherungen · Small micro III blade fuses
Fusibles plats miniatures micro III · Fusibles miniaturas de enchufe micro III

Type	V	A	i		
501805	32	5	Hellbraun · light brown	50	500
501875	32	7,5	Braun · brown	50	500
501810	32	10	Rot · red	50	500
501815	32	15	Hellblau · light blue	50	500

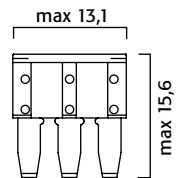

Kleine bolt-on Sicherungen · Small bolt-on fuses Fusibles miniatures bolt-on · Fusibles miniaturas bolt-on

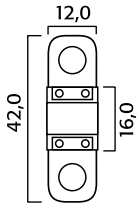

Type	V	A	i		
7048030	58	30	Orange · orange	10	100
7048040	58	40	Grün · green	10	100
7048050	58	50	Rot · red	10	100
7048060	58	60	Gelb · yellow	10	100
7048070	58	70	Braun · brown	10	100
7048080	58	80	Weiß · white	10	100
7048100	58	100	Blau · blue	10	100
7048125	58	125	Rosa · pink	10	100
7048150	58	150	Grau · grey	10	100
7048175	58	175	Hellbraun · light brown	10	100
7048200	58	200	Violett · violet	10	100

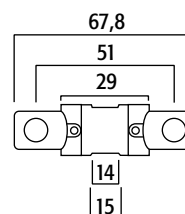
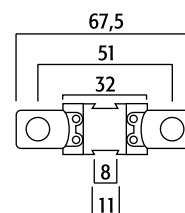

Große bolt-on Sicherungen · Big bolt-on fuses
Fusibles grands bolt-on · Fusibles grandes bolt-on

Type	V	A	i		
8048080	32	80	Rot · red	10	50
8048100	32	100	Gelb · yellow	10	50
8048125	32	125	Grün · green	10	50
8048150	32	150	Orange · orange	10	50
8048175	32	175	Weiß · white	10	50
8048200	32	200	Blau · blue	10	50
8048225	32	225	Hellbraun · light brown	10	50
8048250	32	250	Rosa · pink	10	50
8048300	32	300	Grau · grey	10	50
8048350	32	350	Dunkelgrün · dark green	10	50
8048400	32	400	Violett · violet	10	50
8048450	32	450	Ockergelb · yellow ochre	10	50
8048500	32	500	Braun · brown	10	50
8058080	70	80	Rot · red	10	50
8058100	70	100	Gelb · yellow	10	50
8058125	70	125	Grün · green	10	50
8058150	70	150	Orange · orange	10	50
8058175	70	175	Weiß · white	10	50
8058200	70	200	Blau · blue	10	50
8058225	70	225	Hellbraun · light brown	10	50
8058250	70	250	Rosa · pink	10	50
8058300	70	300	Grau · grey	10	50
8058350	70	350	Dunkelgrün · dark green	10	50
8058400	70	400	Violett · violet	10	50
8058450	70	450	Dunkelgelb · dark yellow	10	50
8058500	70	500	Braun · brown	10	50



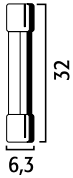

Glassicherungen · Glass fuses · Fusibles en verre · Fusibles de vidrio



Type	V	A	i			
3201	32	1	6,3x32 mm	SAE J554	50	500
3203	32	3	6,3x32 mm	SAE J554	50	500
3204	32	4	6,3x32 mm	SAE J554	50	500
3205	32	5	6,3x32 mm	SAE J554	50	500
3210	32	10	6,3x32 mm	SAE J554	50	500
3215	32	15	6,3x32 mm	SAE J554	50	500
3220	32	20	6,3x32 mm	SAE J554	50	500
3225	32	25	6,3x32 mm	SAE J554	50	500
3230	32	30	6,3x32 mm	SAE J554	50	500
3240	32	40	6,3x32 mm	SAE J554	50	500

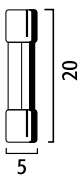

Glassicherungen · Glass fuses · Fusibles en verre · Fusibles de vidrio



Type	V	A	i			
1014005	32	0,5	5x20 mm, Flink · quick · rapide · rápido		50	500
1014010	32	1	5x20 mm, Flink · quick · rapide · rápido		50	500
1014012	32	1,25	5x20 mm, Flink · quick · rapide · rápido		50	500
1014016	32	1,6	5x20 mm, Flink · quick · rapide · rápido		50	500
1014020	32	2	5x20 mm, Flink · quick · rapide · rápido		50	500
1014025	32	2,5	5x20 mm, Flink · quick · rapide · rápido		50	500
1014031	32	3,15	5x20 mm, Flink · quick · rapide · rápido		50	500
1014040	32	4	5x20 mm, Flink · quick · rapide · rápido		50	500
1014050	32	5	5x20 mm, Flink · quick · rapide · rápido		50	500
1014063	32	6,3	5x20 mm, Flink · quick · rapide · rápido		50	500
1014100	32	10	5x20 mm, Flink · quick · rapide · rápido		50	500
1014150	32	15	5x20 mm, Flink · quick · rapide · rápido		50	500



Thermoplastische Sicherungen · Thermoplastic fuses
Fusibles thermoplastique · Fusibles termoplásticoa

Ehemals Keramiksicherungen · Formerly ceramic fuse · Fusibles céramiques autrefois · Antes fusibles cerámica

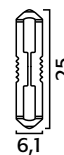
Type	V	A	i		
124805	32	5	Gelb · yellow	100	3600
124808	32	8	Weiß · white	100	3600
124816	32	16	Rot · red	100	3600
124825	32	25	Blau · blue	100	3600
124840	32	40 (25)	Schwarz · black	100	3600



Type J

Type	V	A	i		
609020	32	20	Blau · blue	10	100
609025	32	25	Weiß · white	10	100
609030	32	30	Rosa · pink	10	100
609040	32	40	Grün · green	10	100
609050	32	50	Rot · red	10	100
609060	32	60	Gelb · yellow	10	100

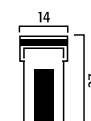

Type JLP

Type	V	A	i		
608920	58	20	Blau · blue	10	100
608925	58	25	Weiß · white	10	100
608930	58	30	Rosa · pink	10	100
608940	58	40	Grün · green	10	100
608950	58	50	Rot · red	10	100
608960	58	60	Gelb · yellow	10	100

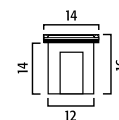



Type J micro

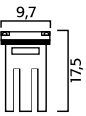

Type	V	A	i		
608815	32	15	Grau · grey	10	100
608820	32	20	Blau · blue	10	100
608825	32	25	Weiß · white	10	100
608830	32	30	Rosa · pink	10	100
608840	32	40	Grün · green	10	100

Type JMS



Type	V	A	i		
608715	32	15	Grau · grey	10	100
608720	32	20	Blau · blue	10	100
608725	32	25	Weiß · white	10	100
608730	32	30	Rosa · pink	10	100
608740	32	40	Grün · green	10	100
608750	32	50	Rot · red	10	100
608760	32	60	Gelb · yellow	10	100

Type B

Type	V	A	i		
604830	32	30	Rosa · pink	10	50
604840	32	40	Grün · green	10	50
604850	32	50	Rot · red	10	50
604860	32	60	Gelb · yellow	10	50
604870	32	70	Braun · brown	10	50
604880	32	80	Schwarz · black	10	50
604900	32	100	Blau · blue	10	50
604920	32	120	Weiß · white	10	50
604940	32	140	Dunkelrot · dark red	10	50

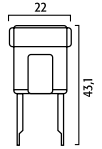

Type AS

Type	V	A	i		
605020	32	20	Blau · blue	10	50
605030	32	30	Rosa · pink	10	50
605040	32	40	Grün · green	10	50
605050	32	50	Rot · red	10	50
605060	32	60	Gelb · yellow	10	50

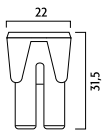

Type CS

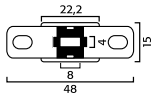

Type	V	A	i		
606830	32	30	Rosa · pink	10	50
606840	32	40	Grün · green	10	50
606850	32	50	Rot · red	10	50
606860	32	60	Gelb · yellow	10	50
606870	32	70	Braun · brown	10	50
606880	32	80	Schwarz · black	10	50
6068100	32	100	Blau · blue	10	50
6068120	32	120	Weiß · white	10	50
6068140	32	140	Dunkelrot · dark red	10	50

Type C

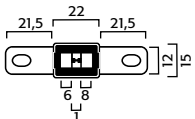

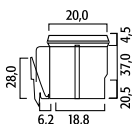

Type	V	A	i		
607030	32	30	Rosa · pink	10	50
607040	32	40	Grün · green	10	50
607050	32	50	Rot · red	10	50
607060	32	60	Gelb · yellow	10	50
607080	32	80	Schwarz · black	10	50
6070100	32	100	Blau · blue	10	50
6070120	32	120	Weiß · white	10	50

Type E





Type	V	A	i		
609545	32	45	Rot · red	10	50
609565	32	65	Schwarz · black	10	50
609575	32	75	Grau · grey	10	50

ET Sicherungen · ET fuses · ET fusibles · ET fusibles

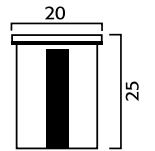
Type	V	A	i		
6091050	58	50	Rot · red	10	50
6091060	58	60	Gelb · yellow	10	50
6091070	58	70	Braun · brown	10	50
6091080	58	80	Schwarz · black	10	50
6091100	58	100	Blau · blue	10	50
6091125	58	125	Rosa · pink	10	50
6091150	58	150	Grau · grey	10	50



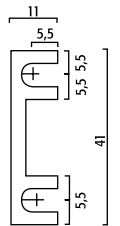

Dieselstreifen · Fuse strips · Fusibles lames · Fusibles de cinta

Type	V	A	i		
38030	32	30		50	500
38040	32	40		50	500
38050	32	50		50	500
38060	32	60		50	500
38080	32	80		50	500
38100	32	100		50	500



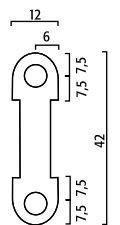

Type HSB

Type	V	A	i		
39030	32	30		50	500
39040	32	40		50	500
39050	32	50		50	500
39060	32	60		50	500
39080	32	80		50	500
39100	32	100		50	500
39110	32	110		50	500
39125	32	125		50	500
39150	32	150		50	500
39175	32	175		50	500



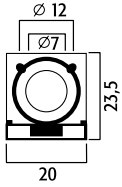

Kompaktsicherungen · Compact fuses · Fusibles compacts · Fusibles compactos





Type	V	A	i		
9048050	58	50		10	100
9048075	58	75		10	100
9048100	58	100		10	100
9048125	58	125		10	100
9048150	58	150		10	100
9048175	58	175		10	100
9048200	58	200		10	100
9048250	58	250		10	100
9048300	58	300		10	100

Batterieklemme · Battery clamp · Borne de batterie · Abrazadera batería

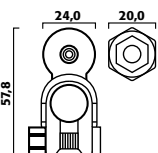
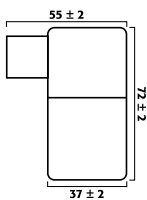
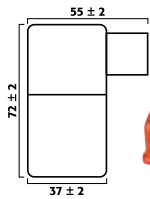
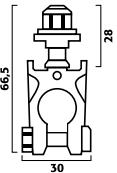
Type	i		
924801	Batterieklemme für 9048xx, gerade, rot Battery clamp for 9048xx, straight, red Borne de batterie, droit, rouge Abrazadera batería, recto, rojo	1	
924801R	Abdeckung für 924801, Kabel rechts Cover for 924801, cable on the right Couvercle pour 924801, cable à droit Tapa para 924801, cable derecha	1	
924801L	Abdeckung für 924801, Kabel links Cover for 924801, cable on the left Couvercle pour 924801, cable à gauche Tapa para 924801, cable izquierdo	1	
924802	Batterieklemme für 9048xx, abgewinkelt, schwarz Battery clamp for 9048xx, angled, black Borne de batterie, angulaire, noir Abrazadera batería, en ángulo, negro	1	



MB Sicherungen · MB fuses · Fusibles MB · Fusibles MB

Type	V	A	i		
315805	32	5	Orange · orange 6 Pins	3	3
315875	32	7,5	Braun · brown 6 Pins	3	3
315820	32	5 & 7,5	Set of 3 x 315805 and 3 x 315875	6	6

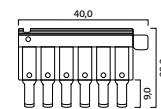

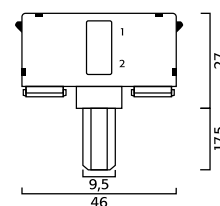

MSB Sicherungen · MSB fuses · Fusibles MSB · Fusibles MSB

Type	A	i		
316801	100, 30	Multi Element SloBlow Fuse MSB, Type A, 2 circuits	10	750
316802	70, 100	Multi Element SloBlow Fuse MSB, Type A, 2 circuits	10	750
316803	70, 120	Multi Element SloBlow Fuse MSB, Type A, 2 circuits	10	750
316804	100, 40	Multi Element SloBlow Fuse MSB, Type A, 2 circuits	10	750
316805	120, 40	Multi Element SloBlow Fuse MSB, Type A, 2 circuits	10	750
316806	120, 60	Multi Element SloBlow Fuse MSB, Type A, 2 circuits	10	750
316807	100, 60	Multi Element SloBlow Fuse MSB, Type A, 2 circuits	10	750
316808	60, 50	Multi Element SloBlow Fuse MSB, Type A, 2 circuits	10	750
316809	80, 50	Multi Element SloBlow Fuse MSB, Type A, 2 circuits	10	750
316810	80, 70	Multi Element SloBlow Fuse MSB, Type A, 2 circuits	10	750



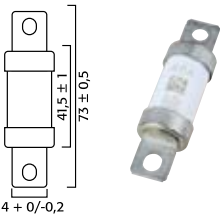
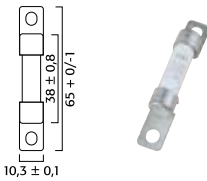
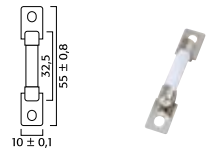

EV Sicherungen · EV fuses · Fusibles EV · Fusibles EV



Type	V	A	i		
EVM40001	450	1	M4, 45mm, Ausschaltvermögen 2 kA breaking capacity 2 kA · pouvoir de coupure 2 kA · amperaje de ruptura 2 kA	1	1
EVM40005	450	5	M4, 45mm, Ausschaltvermögen 2 kA breaking capacity 2 kA · pouvoir de coupure 2 kA · amperaje de ruptura 2 kA	1	1
EVM50015	500	15	M5, 53,5 mm, Ausschaltvermögen 20 kA breaking capacity 20 kA · pouvoir de coupure 20 kA · amperaje de ruptura 20 kA	1	1
EVM50020	500	20	M5, 53,5 mm, Ausschaltvermögen 20 kA breaking capacity 20 kA · pouvoir de coupure 20 kA · amperaje de ruptura 20 kA	1	1
EVM50030	500	30	M5, 53,5 mm, Ausschaltvermögen 20 kA breaking capacity 20 kA · pouvoir de coupure 20 kA · amperaje de ruptura 20 kA	1	1
EVM50040	500	40	M5, 53,5 mm, Ausschaltvermögen 20 kA breaking capacity 20 kA · pouvoir de coupure 20 kA · amperaje de ruptura 20 kA	1	1
EVM50050	450	50	M5, 53,5 mm, Ausschaltvermögen 20 kA breaking capacity 20 kA · pouvoir de coupure 20 kA · amperaje de ruptura 20 kA	1	1
EVM60060	500	60	M5, 53,5 mm, Ausschaltvermögen 20 kA breaking capacity 20 kA · pouvoir de coupure 20 kA · amperaje de ruptura 20 kA	1	1
EVM60070	500	70	M5, 53,5 mm, Ausschaltvermögen 20 kA breaking capacity 20 kA · pouvoir de coupure 20 kA · amperaje de ruptura 20 kA	1	1
EVM60080	500	80	M5, 53,5 mm, Ausschaltvermögen 20 kA breaking capacity 20 kA · pouvoir de coupure 20 kA · amperaje de ruptura 20 kA	1	1
EVM60100	500	100	M6, 60 mm, Ausschaltvermögen 20 kA breaking capacity 20 kA · pouvoir de coupure 20 kA · amperaje de ruptura 20 kA	1	1
EVM60125	500	125	M6, 60 mm, Ausschaltvermögen 20 kA breaking capacity 20 kA · pouvoir de coupure 20 kA · amperaje de ruptura 20 kA	1	1

EV Sicherungen · EV fuses · Fusibles EV · Fusibles EV

Type	V	A	i		
EVM80150	500	150	M8, 74,8 mm, Ausschaltvermögen 16 kA breaking capacity 16 kA · pouvoir de coupure 16 kA · amperaje de ruptura 16 kA	1	1
EVM80175	500	175	M8, 74,8 mm, Ausschaltvermögen 16 kA breaking capacity 16 kA · pouvoir de coupure 16 kA · amperaje de ruptura 16 kA	1	1
EVM80200	500	200	M8, 74,8 mm, Ausschaltvermögen 16 kA breaking capacity 16 kA · pouvoir de coupure 16 kA · amperaje de ruptura 16 kA	1	1
EVM80225	500	225	M8, 74,8 mm, Ausschaltvermögen 16 kA breaking capacity 16 kA · pouvoir de coupure 16 kA · amperaje de ruptura 16 kA	1	1
EVM80250	500	250	M8, 74,8 mm, Ausschaltvermögen 16 kA breaking capacity 16 kA · pouvoir de coupure 16 kA · amperaje de ruptura 16 kA	1	1
EVM80300	500	300	M8, 74,8 mm, Ausschaltvermögen 16 kA breaking capacity 16 kA · pouvoir de coupure 16 kA · amperaje de ruptura 16 kA	1	1
EVM80350	500	350	M8, 74,8 mm, Ausschaltvermögen 16 kA breaking capacity 16 kA · pouvoir de coupure 16 kA · amperaje de ruptura 16 kA	1	1
EVM80400	500	400	M8, 74,8 mm, Ausschaltvermögen 16 kA breaking capacity 16 kA · pouvoir de coupure 16 kA · amperaje de ruptura 16 kA	1	1
EVM80450	500	450	M8, 74,8 mm, Ausschaltvermögen 16 kA breaking capacity 16 kA · pouvoir de coupure 16 kA · amperaje de ruptura 16 kA	1	1
EVM80500	500	500	M8, 74,8 mm, Ausschaltvermögen 16 kA breaking capacity 16 kA · pouvoir de coupure 16 kA · amperaje de ruptura 16 kA	1	1
EVM100600	500	600	M10, 74,8 mm, Ausschaltvermögen 16 kA breaking capacity 16 kA · pouvoir de coupure 16 kA · amperaje de ruptura 16 kA	1	1
EVM100700	500	700	M10, 74,8 mm, Ausschaltvermögen 16 kA breaking capacity 16 kA · pouvoir de coupure 16 kA · amperaje de ruptura 16 kA	1	1
EVM100800	500	800	M10, 74,8 mm, Ausschaltvermögen 16 kA breaking capacity 16 kA · pouvoir de coupure 16 kA · amperaje de ruptura 16 kA	1	1
EVM100900	500	900	M10, 74,8 mm, Ausschaltvermögen 16 kA breaking capacity 16 kA · pouvoir de coupure 16 kA · amperaje de ruptura 16 kA	1	1
EVM101000	500	1000	M10, 74,8 mm, Ausschaltvermögen 16 kA breaking capacity 16 kA · pouvoir de coupure 16 kA · amperaje de ruptura 16 kA	1	1

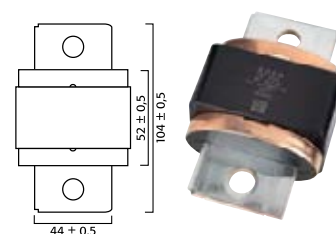
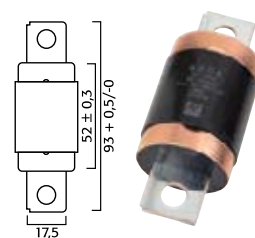
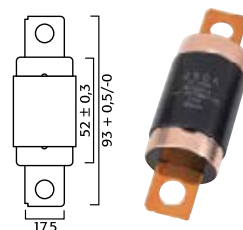

Kabelverbinder · Inline fuse holders · Porte fusibles connecteur · Inline porta fusibles



Type	i			
 <p>31,0</p>	6302	Kabelverbinder für 5028xx · inline fuse holder for 5028xx porte fusible connecteur pour 5028xx · inline porta fusible para 5028xx	10	200
 <p>44,8 31,3</p>	6303	Sicherungshalter für 5018xx · fuse holder for 5018xx porte fusible pour 5018xx · porta fusible para 5018xx	10	200
	6306	Kabelverbinder für 2148xx · inline fuse holder for 2148xx porte fusibles connecteur pour 2148xx · inline porta fusibles para 2148xx Wasserdicht mit Kabel · waterproof with cable imperméable avec cable · impermeable con cable	10	200
 <p>8,4 19,8 35,9 ± 0,5</p>	630603	Sicherungshalter Montageplatte für 6306 · fuse holder mount for 6306 support de porte fusibles our 6306 · soporto porta fusibles para 6306	10	200
	6307	Kabelverbinder für 5148xx · inline fuse holder for 5148xx porte fusibles connecteur pour 5148xx · inline porta fusible para 5148xx Wasserdicht mit Kabel · waterproof with cable imperméable avec cable · impermeable con cable	10	200
	6308	Kabelverbinder für 5038xx · fuse holder for 5038xx porte fusible connecteur pour 5038xx · japonais porta fusible para 5038xx	10	200
 <p>37 16,7 26,5</p>	6309	Sicherungshalter für 5148xx mit Kabel · fuse holder for 5148xx with cable porte fusible pour 5148xx avec cable · porta fusible para 5148xx con cable	10	200
 <p>15 54</p>	121400	Kabelverbinder für 1014xxx · inline fuse holder for 1014xxx porte fusible pour 1014xxx · porta fusible para 1014xxx	1	100
	124800	Kabelverbinder für Keramiksicherungen · inline fuse holder for ceramic fuses porte fusible connecteur pour les fusibles céramiques · inline porta fusible para los fusibles céramicas Mit Sicherung 8 A · with fuse 8 A · avec fusible 8 A · con fusible 8 A	10	100

Für 2148xx · For 2148xx · Pour 2148xx · Para 2148xx

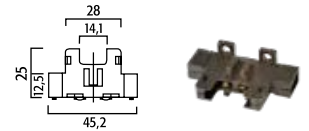
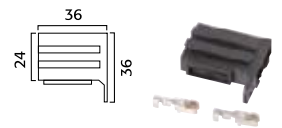
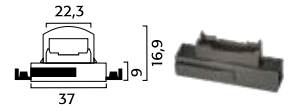
Type	i		
1135	Sicherungshalter mit Crimp-Kontakten und Schutzkappe fuse holder with crimp contacts and cap porte fusible avec cosses à sertir et avec capuchin porta fusible con contactos crimp y con cubierta protectora	10	100
2211	Sicherungshalter mit Crimp-Kontakten, zusammensteckbar mit Relaissockel 2222 fuse holder with crimp contacts, stackable with relays sockets 2222 porte fusible avec cosses à sertir, peuvent être mis ensemble avec les culots pour relais 2222 porta fusible con contactos crimp, insertables con los portarelés 2222	10	10
1110	Sicherungshalter mit Flachsteckern, mit Schutzhaube, zusammensteckbar fuse holder with blade terminals, stackable porte fusible avec cosses plats, peuvent être mis ensemble porta fusible con enchufes planos, insertables	10	10
178200	Sicherungshalter mit Flachsteckern, zusammensteckbar fuse holder with blade terminals, stackable porte fusible avec cosses plats, peuvent être mis ensemble porta fusible con enchufes planos, insertables	10	10
1020	Sicherungshalter mit Flachsteckern, zusammensteckbar, aus Bakelit fuse holder with blade terminals, stackable, bakelite porte fusible avec cosses plats, peuvent être mis ensemble porta fusible con enchufes planos, insertables	10	10



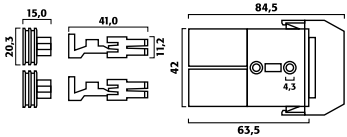
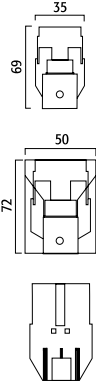

Für 3148xx · For 3148xx · Pour 3148xx · Para 3148xx

Type			
324800	Sicherungshalter für 3148xx mit Schraubanschluss fuse holder for 3148xx with screw connection porte fusible pour 3148xx avec connexion à vis porta fusible para 3148xx con conexión de rosca	1	100
324822	Abdeckung zu 314800 · cover for 314800 couvercle pour 314800 · tapa para 314800	1	100
324844	Sicherungshalter 324800 und Abdeckung 324822 fuse holder 324800 and cover 324822 porte fusible 324800 et couverture 324822 porta fusible 324800 y tapa 324822	1	100
324860	Sicherungshalter für 3148xx mit Kabel von 2,5 mm ² - 6 mm ² fuse holder for 3148xx with cable from 2,5 mm ² - 6 mm ² porte fusible pour 3148xx avec cable de 2,5 mm ² à 6 mm ² porta fusible para 3148xx con cable de 2,5 mm ² - 6 mm ²	1	1
324870	Sicherungshalter für 3148xx mit Kabel von 6 mm ² - 10 mm ² fuse holder for 3148xx with cable from 6 mm ² - 10 mm ² porte fusible pour 3148xx avec cable de 6 mm ² à 10 mm ² porta fusible para 3148xx con cable de 6 mm ² - 10 mm ²	1	1



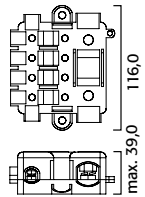
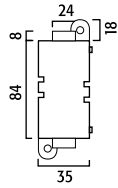
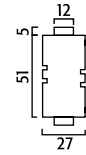

Sicherungshalter · Fuse holders · Porte fusibles · Porta fusibles

Type	A		
724800	Sicherungshalter für 7048xx · fuse holder for 7048xxx porte fusible pour 7048xx · porta fusible para 7048xxx	1	1
824800	Sicherungshalter für 8048xx · fuse holder for 8048xxx porte fusible pour 8048xx · porta fusible para 8048xxx	1	1
372400	Sicherungshalter für 4x 7048xxx mit max. 200 A und 1x 8048xxx Fuse holder for 4x 7048xxx with 200 A max. and 1x 8048xxx Porte fusibles pour 4x 7048xxx à max. 200 A et 1x fusible 8048xxx Porta fusible para 4x 7048xxx de max. 200 A y 1x 8048xxx	1	1

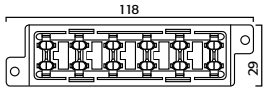

Sicherungsbox · Fusebox · boîte à fusibles · caja de fusibles



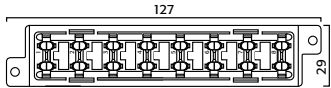

Type	i		
234600	Sicherungsbox · Fusebox · Boite à fusibles · Caja de fusibles Inhalt · Contents · Contenu · Contenido 1 x Sicherungsbox mit Deckel · 3 x Verbinder 1 x Fusebox with cover · 3 x connector 1 x boîte à fusibles avec couvercle · 3 x connecteur 1 x caja de fusibles con tapa · 3 x conector	1	300



234800	Sicherungsbox · Fusebox · Boite à fusibles · Caja de fusibles Inhalt · Contents · Contenu · Contenido 1 x Sicherungsbox mit Deckel · 4 x Verbinder 16 x sekundär Verriegelung 1 x Fusebox with cover · 4 x connector 16 x secondary lock 1 x boîte à fusibles avec couvercle · 4 x connecteur 16 x verrou secondaire 1 x caja de fusibles con tapa · 4 x conector 16 x bloqueo secundario	1	250
--------	--	---	-----

Circuit+

Type	A		
630701	Sicherungshalter mit gesichertem zusätzlichen Stromkreis für Mini Sicherungen mit max. 15 A Fuse holder with secured additional circuit for mini fuses with 15 A max Porte fusibles avec circuit supplémentaire pour les fusibles plats miniatures avec un maximum de 15 A Porta fusibles con circuito asegurado adicional para fusibles miniatura con maximo 15 A	10	10
630501	Sicherungshalter mit gesichertem zusätzlichen Stromkreis für Mikro II Sicherungen mit max. 10 A Fuse holder with secured additional circuit for micro II fuses with 10 A max Porte fusibles avec circuit supplémentaire pour les fusibles micro II avec un maximum de 10 A Porta fusibles con circuito asegurado adicional para fusibles micro II con maximo 10 A	10	10
630801	Sicherungshalter mit gesichertem zusätzlichen Stromkreis für Mini LP Sicherungen mit max. 10 A Fuse holder with secured additional circuit for mini LP fuses with 10 A max Porte fusibles avec circuit supplémentaire pour les fusibles mini LP avec un maximum de 10 A Porta fusibles con circuito asegurado adicional para fusibles mini LP con maximo 10 A	10	10
630601	Sicherungshalter mit gesichertem zusätzlichen Stromkreis für reguläre Sicherungen mit max. 15 A Fuse holder with secured additional circuit for regular fuses with 15 A max Porte fusibles avec circuit supplémentaire pour les fusibles plats avec un maximum de 15 A Porta fusibles con circuito asegurado adicional para fusibles con maximo 15 A	10	10

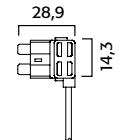
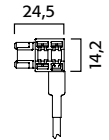
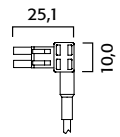
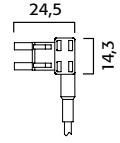





Relais und Blinkgeber
Relays and flashers
Relais et centrales clignotantes
Relés y destelladores





FLÖSSER Relais

Schaltrelais werden benutzt, um Spannungsabfälle und damit Leistungsverluste in den Zuleitungen zu den elektrischen Verbraucherstellen zu vermeiden. Denn schon ein Spannungsabfall von 10% vom Normalwert führt zu einem Leistungsabfall der angeschlossenen Scheinwerferlampen von 33%!

Wir bieten zwei Arten von Schaltrelais an: Schließer und Wechsler. Bei einem Schließer wird über einen Schalter im Bedarfsfall der Kontakt geschlossen und Strom fließt zur gewünschten Stelle (z.B. Scheinwerfer, Hupen, Ventilatoren, Alarmanlagen etc.); Wechsler hingegen schalten bei Betätigung von einem Verbraucher auf einen anderen über (z.B. von Hupe zu Fanfare, von kleiner Stufe des Ventilators zur großen Stufe etc.).

Wesentliche Qualitätsmerkmale bei Relais sind die verwendeten Materialien, die perfekte Wicklung der Spule, sowie die exakte Positionierung der Kontaktpunkte. All dies garantiert ein exaktes Funktionieren über eine lange Lebensdauer hinweg. International vereinheitlicht ist die Bezeichnung der Anschlüsse: z.B. ist der Kontakt mit Bezeichnung 30 nur für die Stromzufuhr, der Kontakt 87 immer nur für den Verbraucher.

Die neue Generation der FLÖSSER Relais hat farbcodierte Bodenplatten je nach Steckerkonfiguration und trägt „E“- und „CE“-Zeichen zum Zeichen der EMV (elektromagnetischen Verträglichkeit).

FLÖSSER Relays

Relays are used to avoid voltage drops and resulting performance losses of attached voltage consumers. A drop of only 10% of the nominal voltage used in your car may already lead to performance losses of light output greater than 33%!

We offer two types of mini relays: normally open relays and changeover relays. The normally open relays is used to close the electrical contact and to switch your consumer on; typical appliances are head lights, additional driving or fog lights, horns, alarms etc. The changeover relay switches from one consumer to another, e.g. switching from horns to fanfares or when adjusting the ventilator speed, etc.

Essential quality features of relays are the material used, the perfect winding of the coil and the exact positioning of contact points. All these result in good performance over a long lifetime. The designation of pins follows an international rule, e.g. the pin 30 is used only for "current in", while 87 designates the pin "current out".

The new generation of FLÖSSER relays have color coded bottom plates and carry the "E" and "CE" sign as proof of electromagnetic compatibility.





Le relais FLÖSSER

Les relais en général servent à protéger de chutes de tensions éventuelles et ainsi d'une perte de performance d'une application quelconque. En effet une chute de tension de 10% peut produire une perte de la performance lumineuse atteignant 33%!

FLÖSSER propose 2 types de relais: le contacteur et l'inverseur. Le premier ferme le circuit électrique lors du branchement afin de mettre en marche des applications types éclairage, avertisseurs ou encore ventilateur. Le second sert en revanche à opérer un lien d'une application à une autre comme des feux de routes au pleins phares ou encore d'un niveau de ventilation au suivant.

Le niveau de qualité d'un relais dépend des matériaux employés, de la précision du bobinage ou encore du positionnement précis des points de contacts. Ce sont ces éléments qui assurent une durée de vie optimisée du relais. En outre les contacts sur les relais FLÖSSER sont aux normes internationales – ainsi le 30 correspond à l'entrée, le 87 à la sortie du courant de l'application en question. Les boîtiers de la nouvelle génération des relais FLÖSSER possèdent un fond coloré. Les couleurs sont codifiées selon la configuration des terminaux.

Ces nouveaux relais sont également homologués et portent les signes "E" et "CE" comme preuve de leur compatibilité électromagnétique.

Relés FLÖSSER



Relés en general sirven para evitar bajas de tensión y así pérdidas de potencia en las conducciones hacia las aplicaciones eléctricas de consumo. Solamente una pérdida de tensión del 10% del valor nominal conduce a una pérdida de potencia luminosa de un 33%.

FLÖSSER ofrece dos tipos de relés: el contactador y el inversor. El primero cierra el circuito eléctrico con el fin de poner en marcha las aplicaciones deseadas (focos, bocinas, ventiladores, sistemas de alarma, etc.). El segundo, en cambio, sirve para cambiar de una aplicación a otra (de bocina a corneta, de un nivel de ventilación al siguiente).

Características de calidad fundamentales de un relé son los materiales empleados, la precisión del bobinado y el posicionamiento preciso de los contactos. Estos son los elementos que aseguran un funcionamiento exacto y una duración de vida óptima del relé. Además los contactos de los relés FLÖSSER siguen las normas internacionalmente reconocidas: así el contacto 30 corresponde a la entrada, el 87 a la salida de la corriente hacia la aplicación en cuestión.



La nueva generación de relés FLÖSSER tienen la placa del fondo con códigos de colores y llevan los signos de homologación "E" y "CE" para mostrar su compatibilidad electromagnética.

Schließer mit 4 Anschlüssen · Normally open relays with 4 terminals Relais contacteur avec 4 bornes · Cierre con 4 terminales

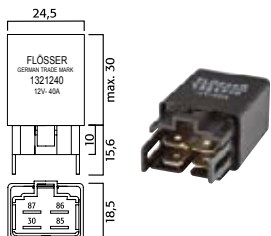
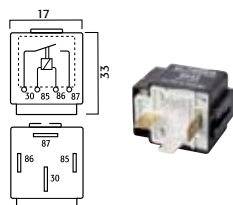
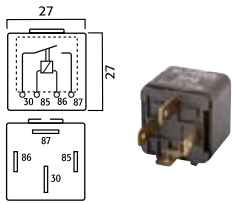
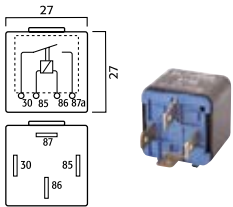
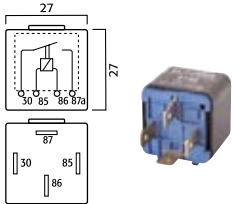
Type	V	A	i		
Alle mit Lasche · All with bracket · Tous avec patte · Todos con grapa					
2142	12	30		10	350
2143	12	30	Mit Widerstand · with resistance avec résistance · con resistencia	10	350
2144	12	40		10	350
4142	24	20		10	350
4143	24	20	Mit Widerstand · with resistance avec résistance · con resistencia	10	350
2242	12	30		10	350
2245	12	30	Mit Widerstand · with resistance avec résistance · con resistencia	10	350
4242	24	20		10	350
2243	12	30	Mit Sicherung · with fuse avec fusible · con fusible	10	350
4243	24	20	Mit Sicherung · with fuse avec fusible · con fusible	10	350
1321240	12	40		10	100



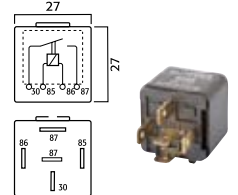

Schließer mit 5 Anschlüssen · Normally open relays with 5 terminals
 Relais contacteur avec 5 bornes · Cierre con 5 terminales

Type	V	A	i		
Alle mit Lasche · All with bracket · Tous avec patte · Todos con grapa					
2252	12	30		10	350
2254	12	40		10	350
2255	12	30	Mit Diode · with diode avec diode · con diodo	10	350
4252	24	20		10	350
4254	24	30		10	350



Wechsler · Changeover relay · Relais inverseur · Relé inversor

Type	V	A	i		
Alle mit Lasche · All with bracket · Tous avec patte · Todos con grapa					
2162	12	20/30		10	350
4162	24	10/20		10	350
2262	12	20/30		10	350
2263	12	20/30	Mit Widerstand · with resistance avec résistance · con resistencia	10	350
2265	12	20/30	Mit Diode · with diode avec diode · con diodo	10	350
2268	12	30/40		10	350
4262	24	10/20		10	350
4268	24	20/30		10	350
4263	24	10/20	Mit Widerstand · with resistance avec résistance · con resistencia	10	350
4265	24	10/20	Mit Diode · with diode avec diode · con diodo	10	350

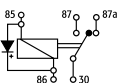
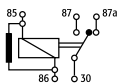
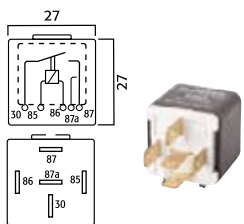
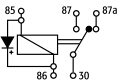
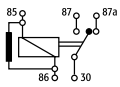
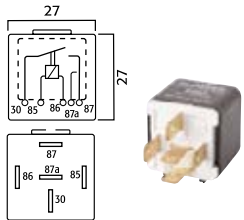
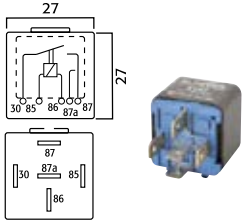

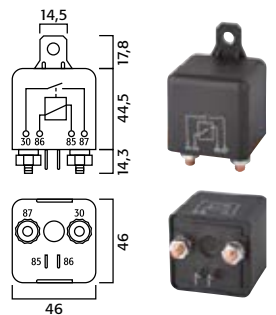
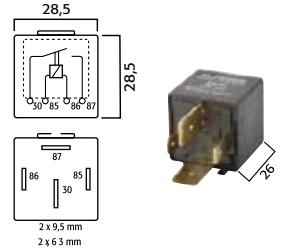

Hochleistungsrelais · High power relay · Relais haute puissance · Relé de alta potencia

Type	V	A	i		
Alle mit Lasche · All with bracket · Tous avec patte · Todos con grapa					
2248	12	50		10	350
2270	12	70		10	350
2271	12	70	Mit Diode · with diode avec diode · con diodo	10	300
2273	12	70	Mit Widerstand · with resistance avec résistance · con resistencia	10	300
9242	12	200	Heavy duty high power Großes Gehäuse · big housing Grande boîte · Caja grande	1	30
2274	24	40		10	350
2275	24	70	Großes Gehäuse · big housing Grande boîte · Caja grande	10	100
2276	24	70	Kleines Gehäuse · Small housing Petite boîte · Caja pequeña	10	300



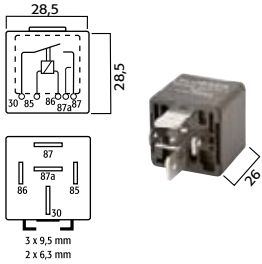

Hochleistungswechsler · High power changeover
Inverseur de haute puissance · Inversor de alta potencia

Type	V	A	i		
Alle mit Lasche · All with bracket · Tous avec patte · Todos con grapa					
2264	12	70/60		10	350
4264	24	40/30		10	350



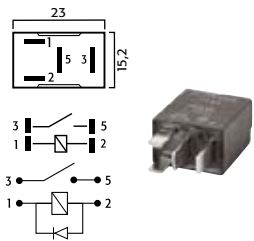

Schließer · Normally open · Contacteur · Cierre

Type	V	A	i		
1141	12	20		10	350
1142	12	25		10	350
1143	12	25	Mit Diode · with diode avec diode · con diodo	10	350
1144	12	25	Mit Widerstand · with resistance avec résistance · con resistencia	10	350
1443	24	10	Mit Diode · with diode avec diode · con diodo	10	350



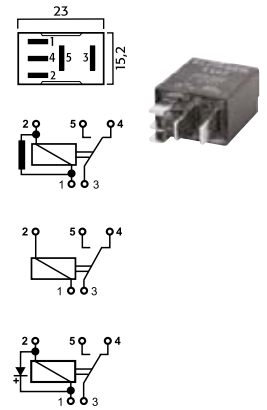

Wechsler · Changeover · Inverseur · Inversor

Type	V	A	i		
1162	12	15/25		10	350
1163	12	15/25	Mit Diode · with diode avec diode · con diodo	10	350
1164	12	15/25	Mit Widerstand · with resistance avec résistance · con resistencia	10	350
1462	24	5/10		10	350
1463	24	5/10	Mit Diode · with diode avec diode · con diodo	10	350
1464	24	5/10	Mit Widerstand · with resistance avec résistance · con resistencia	10	350
1465	24	10/15	Mit Widerstand · with resistance avec résistance · con resistencia	10	350



Ultra Mikro Relais · Ultra micro relays · Ultra micro relais · Ultra micro relés

Type	V	A	i		
1044	12	20	Mit Widerstand · with resistance avec résistance · con resistencia	10	100
1064	12	20/10	Mit Widerstand · with resistance avec résistance · con resistencia	10	100

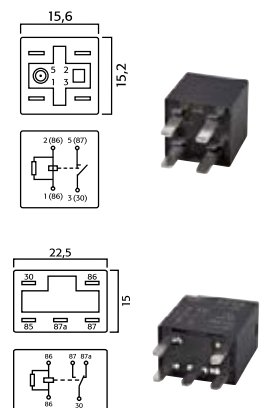

Batterietrennrelais · Battery relays · Batterie relais · Relé de batería

Type	V	A	i		
9458	12	150	Intelligentes Batterietrennrelais Smart battery relay relais de batterie intelligent relé de batería inteligente	1	30

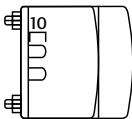
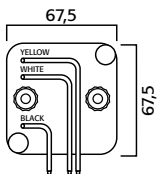
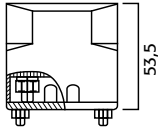
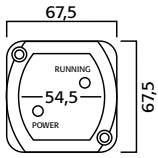

Batterietrennrelais für den gleichzeitigen Einsatz von zwei 12 Volt Batterien.

Das spannungsabhängige Relais erlaubt es, zwei Batterien gleichzeitig zu laden. Wird bei laufendem Motor eine Spannung von 13,3 Volt erreicht, zieht das Relais an und die Zweitbatterie wird zusätzlich zur Anlasserbatterie geladen. Schaltet man den Motor aus, fällt die Bordspannung unter 12,65 Volt und das Relais trennt die Primärbatterie von der Zweitbatterie. Dieses System verhindert, dass sich die Anlasserbatterie entlädt und schützt zudem die empfindliche Elektronik, die an die Zweitbatterie angeschlossen ist, vor Spannungsspitzen beim Starten des Motors. Außerdem können sich bei längerer Standzeit durch den Einsatz des intelligenten Batterietrennrelais die Batterien nicht gegenseitig entladen.

Der optionale Boost-Switch ermöglicht es beide Batterien bei niedrigem Ladezustand zusammen zu schalten, um das Fahrzeug starten zu können.

Voltage Sensitive Battery Relay for simultaneous use of two 12 volt batteries.

The Voltage Sensitive Relay allows two batteries to be charged at the same time. When the engine is running the two battery banks (start and house) can be charged simultaneously. When the voltage drops below 12.65 volts (engine is not running) the relay drops out, separating the batteries. This system prevents the starter battery from draining and protects sensitive electronic equipment powered by the house battery against harmful engine start-up spikes. Additionally, the relay prohibits both batteries from draining each other after a prolonged downtime.

The optional Boost-Switch allows both batteries to be interconnected when the individual charging level is too low to start the vehicle.

Relais déconnecteur actif de batteries pour l'utilisation simultanée de deux batteries de 12 Volt.

Ce relais sensible à la tension permet de charger deux batteries simultanément. Dès que la tension atteint 13,3 Volt après le démarrage du moteur, le relais connecte la batterie secondaire qui se charge en complément de la batterie primaire. Si, après l'arrêt du moteur, la tension tombe sous 12,65 Volt, le relais déconnecte automatiquement la batterie secondaire du système électrique, empêchant ainsi que la batterie principale ne se décharge, et protégeant ainsi tous les équipements électroniques très sensibles reliés à la batterie secondaire lors des pics de charge au cours de la mise en route du moteur. En cas d'arrêt prolongé, cette procédure évite aussi que les deux batteries ne se déchargent réciproquement.

Le Boost-Switch en option permet – en cas de faible charge – de connecter les deux batteries ensemble afin de démarrer le véhicule.

Relé desconector activo de baterías para la utilización simultánea de dos baterías de 12 V.

Este relé sensible a la tensión permite cargar dos baterías simultáneamente. En caso de que, mientras esté encendido el motor, la tensión llegue a 13,3 Volt, el relé se pone en marcha y la segunda batería será cargada adicionalmente a la batería primaria. Si se apaga el motor, la tensión cae debajo de 12,65 Volt y el relé separa la batería primaria de la batería secundaria. Este sistema evita que la batería primaria se descargue y protege además la electrónica sensible que está conectada a la batería secundaria, ante picos de tensión. Además, las baterías en caso de largas paradas, no se pueden descargar mutuamente.

El Boost-Switch opcional permite - en caso de baja carga - juntar las dos baterías con el fin de poder encender el vehículo.

Batterietrennrelais · Battery relays · Batterie relais · Relé de batería

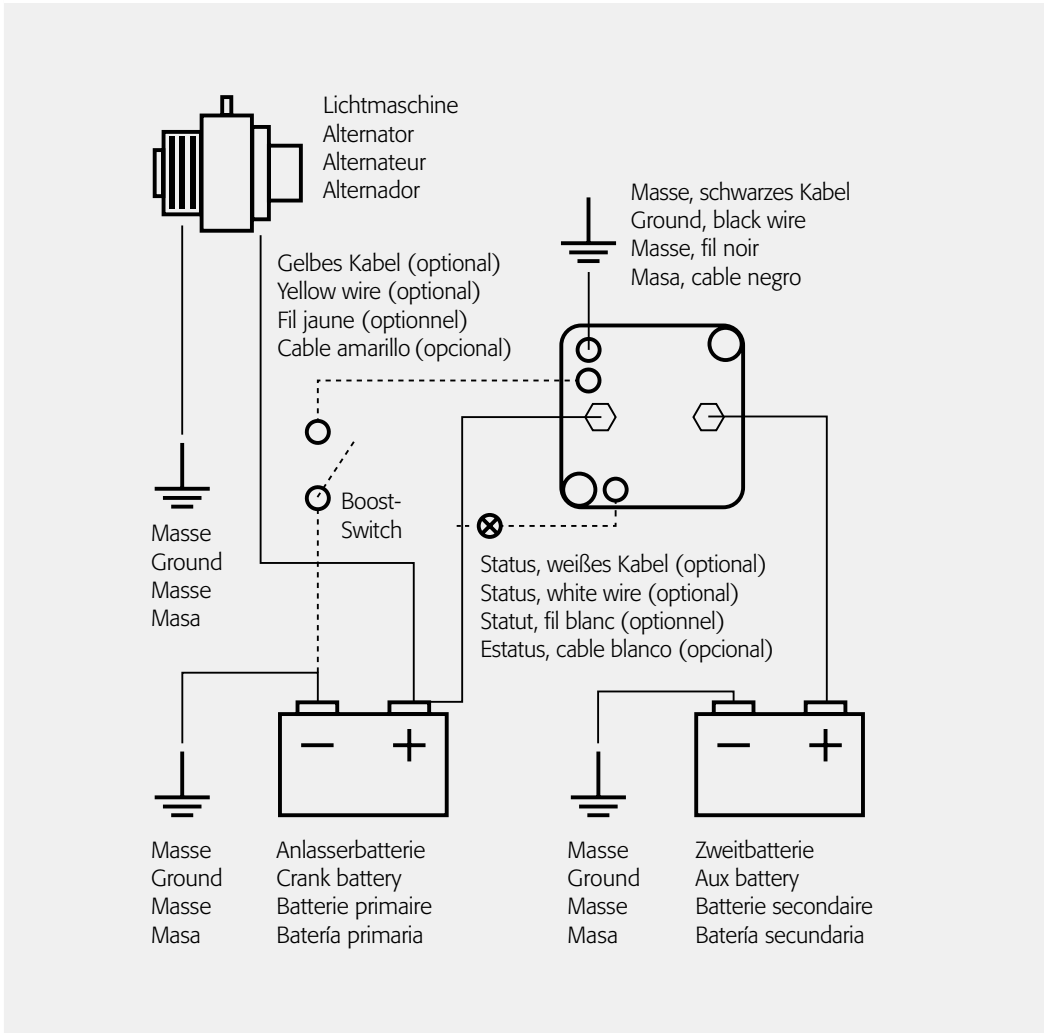



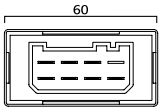
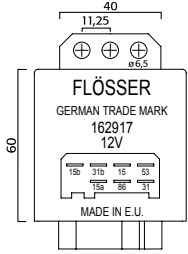

Scheibenwischerrelais · Wiper relay · Relais d'essuie-glace · Relés de limpiaparabrisas

Scheibenwischerrelais · Wiper relay · Relais d'essuie-glace · Relés de limpiaparabrisas



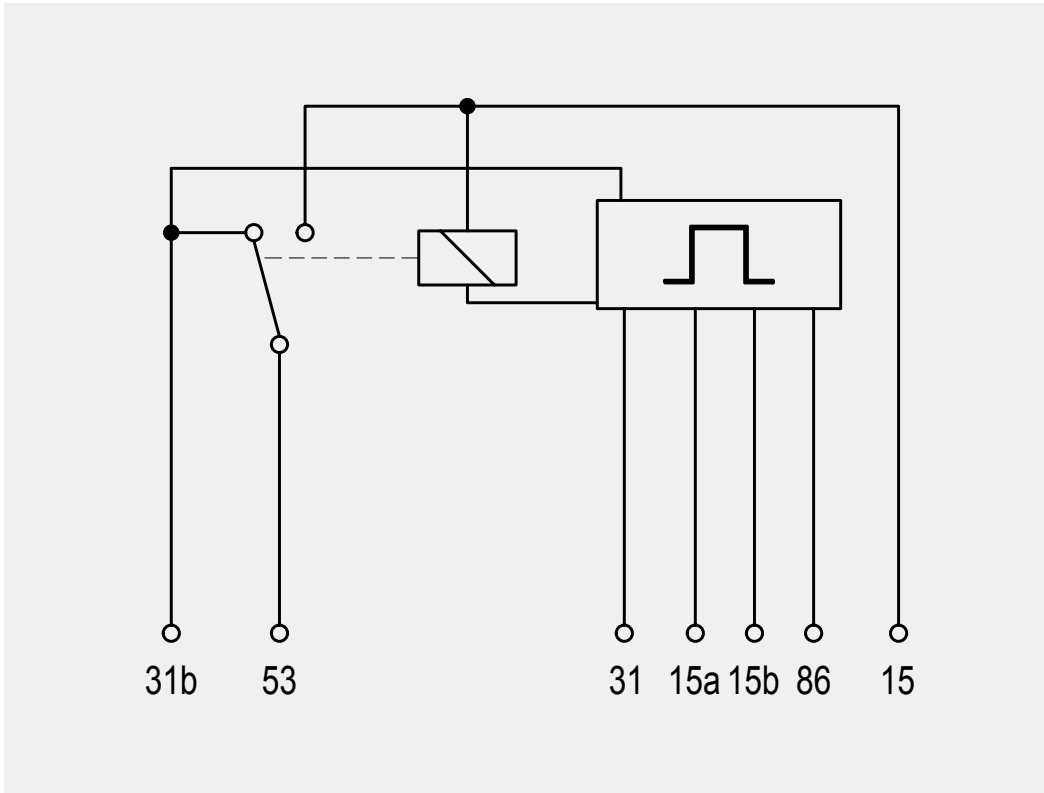

Type	V	i		
162917	12	7 terminals, IP54	5	50

Scheibenwischerrelais · Wiper relay · xx relais · Relés de xx

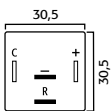
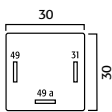
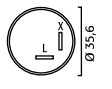
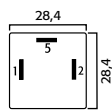
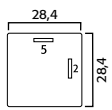
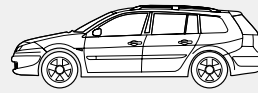
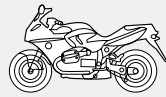

Für Motorräder und Pkw · For motorcycles and cars
Pour motocyclestes et voitures · Para motocicletas y automóviles



Type	V	i		
1620002	12	2 Terminals - für LED - max. 30 W	10	100
1620003	12	3 Terminals - für LED - max. 30 W	10	100
1621002	12	2 Terminals max. 300 W	10	100
1621003	12	3 Terminals max. 300 W	10	100
1622411	12	Kleine Ausführung · ohne Lasche small type · no bracket · petite version · sans patte tipo pequeño · sin grapa 3 Terminals 2/4x21 W	10	100
1622421	12	Mit Lasche · with bracket avec patte · con grapa 3 Terminals 2/4x21 W	10	100
1622425	12	4 Terminals 2/4x21 W SAE Standard	10	100

Für Lkw · For trucks · Pour véhicules commercial · Para vehículos industriales

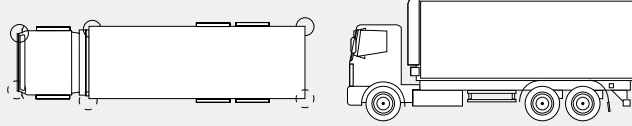

Type	V	i		
1642421	24	3 Terminals 2/4x21 W	10	100
1632421	24	3 Terminals max. 170 W	10	100
1641002	24	2 Terminals max. 150 W	10	100
1641003	24	3 Terminals max. 150 W	10	100
1628821	12 & 24	6 Terminals	1	5
1634852	12 & 24	Max. 170 W Keine Blinklampenüberwachung no control of flashing bulbs sans contrôle de feux clignotants sin control de luces intermitentes	1	5

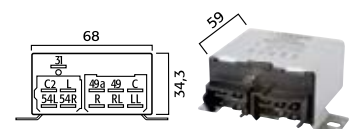
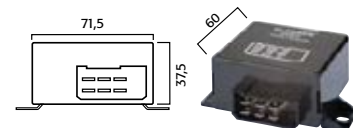
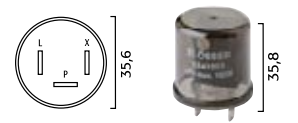
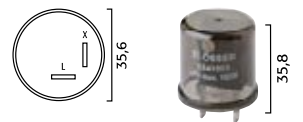
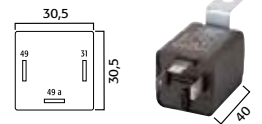









Signalhörner
Signal horns
Avertisseurs
Bocinas

Signalhörner · Disc horns · Avertisseurs · Bocinas

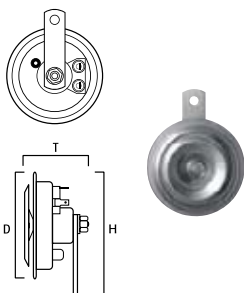
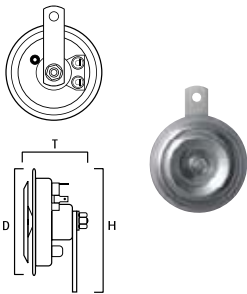
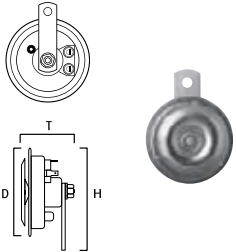
Type	V	i		
123357	12	70 mm disc horn, 340 Hz	1	48
124307	12	70 mm disc horn, 430 Hz	1	48
Dimension		D = 71,5 mm T = 41 mm H = 95 mm		
63359	6	91 mm disc horn, 340 Hz	1	30
123359	12	91 mm disc horn, 340 Hz	1	30
124309	12	91 mm disc horn, 430 Hz	1	30
Dimension		D = 90 mm +/-1 T = 57 mm +/-1 H = 115 mm		
127659	12	Set aus je einem 91 mm Hoch- und Tieftöner set of one 91 mm high and low frequency horn jeu d'avertisseurs 91 mm avec fréquence haute et basse set de bocinas 91 mm con frecuencia alta y baja	1	20
243359	24	91 mm disc horn, 340 Hz	1	30
244309	24	91 mm disc horn, 430 Hz	1	30





Signalhörner · Disc horns · Avertisseurs · Bocinas

Type	V	i		
247659	24	Set aus je einem 91 mm Hoch- und Tieftöner set of one 91 mm high and low frequency horn jeu d'avertisseurs 91 mm avec fréquence haute et basse set de bocinas 91 mm con frecuencia alta y baja	1	20
483359	48	91 mm disc horn, 340 Hz	1	26



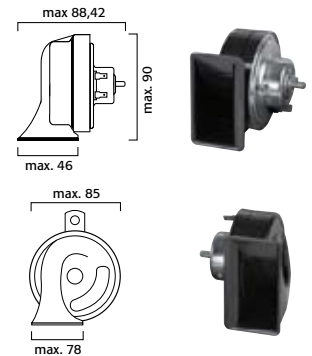

Fanfaren · Fanfare horns · Klaxons · Bocinas tipo caracol

Type	V	i		
129206	12	High 500 Hz Low 410 Hz Set aus je einer Hoch- und Tiefton Fanfare set of one high and low frequency fanfare horn jeu de klaxons avec fréquence haute et basse set de cornetas con frecuencia alta y baja	1	30
249206	24	High 500 Hz Low 410 Hz Set aus je einer Hoch- und Tiefton Fanfare set of one high and low frequency fanfare horn jeu de klaxons avec fréquence haute et basse set de cornetas con frecuencia alta y baja	1	30

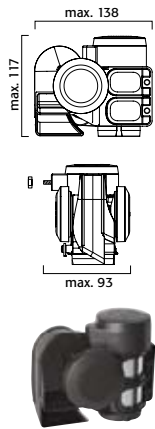

Ultra Air Signalthörner · Ultra Air horns · Ultra Air avertisseurs · Ultra Air bocinas



Type	V	i		
11690120	12	<p>HIGH 660 Hz ± 5% LOW 520 Hz ± 5%</p> <p>≥ 112 dB at 2 m</p> <p>Zweiton-Luftdruckfanfare two-tone air compressor horn claxon à air comprimé et deux sons bocina de aire comprimido y dos tonos</p>	1	18
11690124	24	<p>HIGH 660 Hz ± 5% LOW 520 Hz ± 5%</p> <p>≥ 112 dB at 2 m</p> <p>Zweiton-Luftdruckfanfare two-tone air compressor horn claxon à air comprimé et deux sons bocina de aire comprimido y dos tonos</p>	1	18

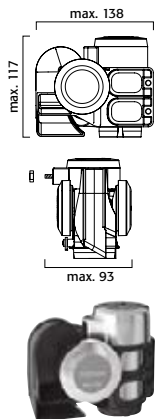

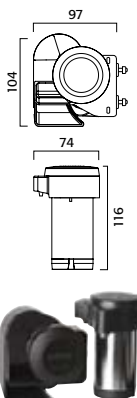

11690122	12	<p>HIGH 660 Hz ± 5% LOW 520 Hz ± 5%</p> <p>≥ 112 dB at 2 m</p> <p>Zweiton-Luftdruckfanfare Chrom Ausführung two-tone air compressor horn chrome finish klaxon à air comprimé et deux sons version chromée bocina de aire comprimido y dos tonos versión cromada</p>	1	18
----------	----	---	---	----





11690320	12	<p>HIGH 660 Hz ± 5% LOW 520</p> <p>≥ 112 dB at 2 m Hz ± 5%</p> <p>Zweiton-Luftdruckfanfare mit seperatem Kompressor two-tone air horn with seperate compressor klaxon à air comprimé et compresseur séparé bocina de aire comprimido con compresor por separado</p>	1	18
----------	----	---	---	----

Ultra Air Signalthörner · Ultra Air horns · Ultra Air avertisseurs · Ultra Air bocinas

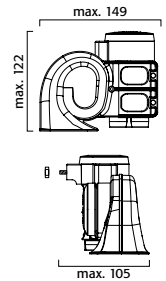
Type	V	i		
11690220	12	300 Hz ± 5% ≥ 112 dB at 2 m Luftdruckfanfare mit tiefem Ton Air horn with low tone klaxon à air comprimé avec ton plus bas bocina de aire comprimido de tono bajo	1	18
11690240	24	300 Hz ± 5% ≥ 112 dB at 2 m Luftdruckfanfare mit tiefem Ton Air horn with low tone klaxon à air comprimé avec ton plus bas bocina de aire comprimido de tono bajo	1	18



Rückfahralarm · Back-up alarm · Avertisseur de recul · Alarma retroceso

Type	V	i		
128097	12-80	97 dB Kombigerät bestehend aus Relais und Hupe in einem Gehäuse. Mit einer Betriebsspannung von 12-80 V ist es sowohl in PKW, LKW, aber auch z.B. in Gabelstaplern verwendbar. Single unit containing relay and horn. Operating from 12-80 V, it is usable in regular cars, trucks, or e.g. fork lifts. Boîtier qui combine un relais et un klaxon. Avec tension de 12 à 80 V, il est utilisable dans les voitures, camions, ou par exemple élévateurs à fourche. Unidad que contiene un relé y una bocina. Tensión operativa de 12-80 Volt, aplicable para autos, camiones o también montacargas.	1	50

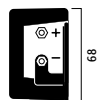
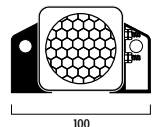





Zubehör
Accessories
Accessoires
Accesorios

Zigarettenanzünder · Cigarette lighters · Allume cigares · Encendedores

Type	V	İ		
181403	12	Ohne Licht · without light · sans lumière · sin luz Großer Knopf · big button · grand bouton · botón grande	1	100
181504	12	Mit LED Licht · with LED light · avec lumière LED · con luz LED	1	100
151511	24	Mit LED Licht · with LED light · avec lumière LED · con luz LED	1	100
181507	12	Mit LED Licht · with LED light · avec lumière LED · con luz LED Kleiner Knopf · small button · petit bouton · botón pequeño	1	100

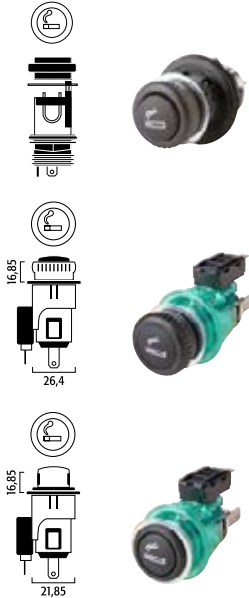

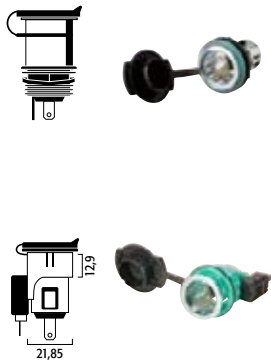

Steckdosen · Power adapters · Prise de courant · Enchufe

Type	V	İ		
181399	12&24	Steckdose mit Deckel · power adapter with cover prise de courant avec couvercle · enchufe con tapa	1	100
181500	12	Steckdose mit LED Licht und Deckel power adapter with LED light and cover prise de courant avec lumière LED et couvercle enchufe con luz LED y tapa	1	100
181512	24	Steckdose mit LED Licht und Deckel power adapter with LED light and cover prise de courant avec lumière LED et couvercle enchufe con luz LED y tapa	1	100



Montageleuchte · Working light · Lampe de travail · Lámpara de taller

Type	V	İ		
300054	12	LED Montageleuchte 250-500 lm Lichtstärke, 4-7,5 h Akkuleistung LED working light, 250-500 lm light output, 4-7,5 h battery life Lampe de travail LED, 250-500 lm, 4-7,5 h durée des piles Lámpara de taller LED 250-500 lm de luz, 4-7,5 h duración	1	1

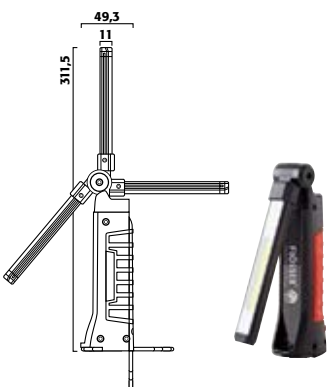



USB Ladegerät · USB charger · Chargeur USB · Cargador USB

Type	V	i		
181740	12&24	DC 12-24 V 20 W 1x USB-A 1x USB-C	1	100





Universalstecker · Universal plug · Fiche universal · Enchufe universal

Type	V	i		
181420	12&24	Mit Sicherung 8 A, passend für alle Zigarettenanzünder und Steckdosen in diesem Katalog with 8 A fuse, suitable for all cigarette lighters and power adapters in this catalogue avec fusible 8 A, utilisable chez tous allumes cigares et prises de courant de ce catalogue con fusible 8 A, aplicable con todos encendedores y enchufes de este catálogo	1	100





Spannungsprüfer · Voltage tester · Controleur de tension · Control de tensión

Type	i		
183044	Für Spannungen 6 - 24 V · for tensions 6 - 24 V pour tensions 6 - 24 V · para tensiones 6 - 24 V	5	100
5149	Ersatzlampe · replacement bulb lampe de réchange · bombilla de reemplazo		



Lampentester · Bulb tester · Testeur d'ampoules · Probador de bombillas

Type	i		
183000	Für Lampen mit 6 - 24 V · for bulbs with 6 - 24 V pour lampes avec 6 - 24 V · para lámparas de 6 - 24 V	1	1
16560	Sicherungstester und Greifer für Stecksicherungen fuse tester and puller for plug-in fuses testeur et pince des fusibles plats probador y pinza para fusibles de enchufe	1	100
16552	Greifer für Stecksicherungen fuse puller for plug-in fuses pince des fusibles plats pinza para fusibles de enchufe	1	100



Lampenfassungen · Bulb sockets · Fiches d'ampoules · Sockets para bombillas

Type	i			
	4444	Fassung für H4 · holder for H4 · fiche pour H4 · socket para H4 Mit 2,5 mm ² Kabel · with 2,5 mm ² cable avec cable de 2,5 mm ² · con cable de 2,5 mm ²	10	100
	4445	Fassung für H4 · holder for H4 · fiche pour H4 · socket para H4 Mit Kabel · with cable · avec cable · con cable	10	300
	4446	Fassung aus Keramik für H4 · ceramic holder for H4 fiche ceramique pour H4 · socket cerámica para H4 Mit Kabel · with cable · avec cable · con cable	10	200
	1444	Fassung für H1 · holder for H1 · fiche pour H1 · socket para H1 Mit Kabel · with cable · avec cable · con cable	10	300
	14442	Fassung für H1 · holder for H1 · fiche pour H1 · socket para H1 Mit Kabel · with cable · avec cable · con cable	10	400
	1445	Fassung für H1 · holder for H1 · fiche pour H1 · socket para H1	10	300
	7444	Fassung für H7 · holder for H7 · fiche pour H7 · socket para H7 Mit Kabel · with cable · avec cable · con cable	10	300
	7446	Fassung aus Keramik für H7 · ceramic holder for H7 fiche ceramique pour H7 · socket cerámica para H7 Mit Kabel · with cable · avec cable · con cable	10	300

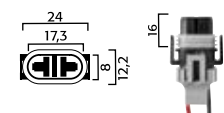
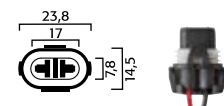
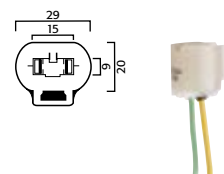
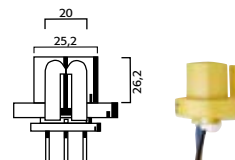
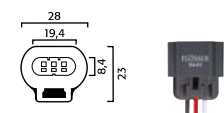
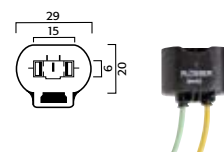
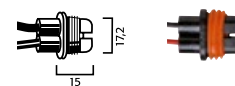

Lampenfassungen · Bulb sockets · Fiches d'ampoules · Sockets para bombillas

Type	i		
9448	Fassung für H8, H9 und H11 · holder for H8, H9 and H11 fiche pour H8, H9 et H11 · socket para H8, H9 y H11 Mit Kabel · with cable · avec cable · con cable	10	300
9445	Fassung für HB3, H10, H12 und HIR1 · holder for HB3, H10, H12 and HIR1 · fiche pour HB3, H10, H12 et HIR1 · socket para HB3, H10, H12 y HIR1 Mit Kabel · with cable · avec cable · con cable	10	200
9449	Fassung für H13 · holder for H13 fiche pour H13 · socket para H13 Mit Kabel · with cable · avec cable · con cable	10	200
9444	Fassung für 9004/9007 · holder for 9004/9007 fiche pour 9004/9007 · socket para 9004/9007 Gelb · yellow Mit Kabel · with cable · avec cable · con cable	1	100
9446	Fassung für HB4 und HIR2 · holder for HB4 and HIR2 fiche pour HB4 et HIR2 · socket para HB4 y HIR2 Mit Kabel · with cable · avec cable · con cable	10	200
9440	Fassung für 880/893/890 · holder for 880/893/890 fiche pour 880/893/890 · socket para 880/893/890 Mit Kabel · with cable · avec cable · con cable	10	300
9441	Fassung für 881/886/894/896 · holder for 881/886/894/896 fiche pour 881/886/894/896 · socket para 881/886/894/896 Mit Kabel · with cable · avec cable · con cable	10	300

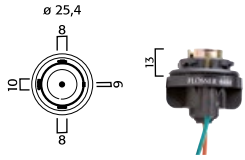

Lampenfassungen · Bulb sockets · Fiches d'ampoules · Sockets para bombillas



Type			
6444	Fassung für Lampen mit BA15s Sockel · holder for bulbs with BA15s socket · fiche pour ampoules avec culot BA15s socket para bombillas con base BA15s Mit Kabel · with cable · avec cable · con cable	10	200

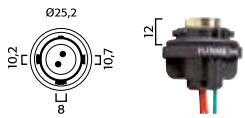

5444	Fassung für Lampen mit BAY15d Sockel · holder for bulbs with BAY15d socket · fiche pour ampoules avec culot BAY15d socket para bombillas con base BAY15d Mit Kabel · with cable · avec cable · con cable	10	200
------	---	----	-----

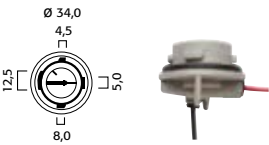

6445	Fassung für Lampen mit BAU15s Sockel · holder for bulbs with BAU15s socket · fiche pour ampoules avec culot BAU15s socket para bombillas con base BAU15s Mit Kabel · with cable · avec cable · con cable	10	200
------	---	----	-----

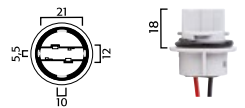

2444	Fassung für Lampen mit Sockel W3x16d · holder for bulbs with socket W3x16d · fiche pour ampoules avec culot W3x16d socket para bombillas con base W3x16d Mit Kabel · with cable · avec cable · con cable	10	200
------	---	----	-----

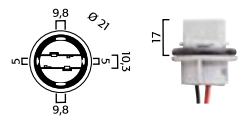

2644	Fassung für Lampen mit Sockel W3x16q · holder for bulbs with socket W3x16q · fiche pour ampoules avec culot W3x16q socket para bombillas con base W3x16q Mit Kabel · with cable · avec cable · con cable	10	200
------	---	----	-----

Lampenfassungen · Bulb sockets · Fiches d'ampoules · Sockets para bombillas

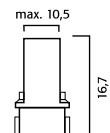
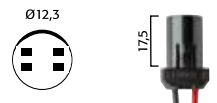
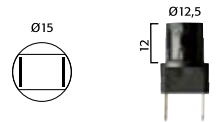
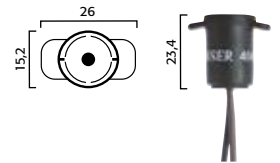
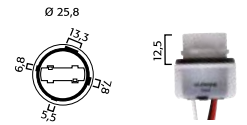
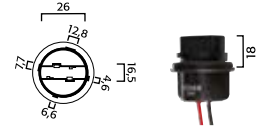

Type	i		
3444	Fassung für Lampen mit Sockel W2,5x16d · holder for bulbs with socket W2,5x16d · fiche pour ampoules avec culot W2,5x16d · socket para bombillas con base W2,5x16d Mit Kabel · with cable · avec cable · con cable	10	150
3644	Fassung für Lampen mit Sockel W2,5x16q · holder for bulbs with socket W2,5x16q · fiche pour ampoules avec culot W2,5x16q · socket para bombillas con base W2,5x16q Mit Kabel · with cable · avec cable · con cable	10	150
4041	Fassung für Lampen mit Sockel BA9s · holder for bulbs with socket BA9s · fiche pour ampoules avec culot BA9s · socket para bombillas con base BA9s mit Kabel · with cable · avec cable · con cable	10	400
4244	Fassung für Glassockellampen mit Sockel W2,1x9,5d · holder for wedge base bulbs with socket W2,1x9,5d · fiche pour ampoules tout verre avec culot W2,1x9,5d · socket para bombillas de vidrio con base W2,1x9,5d	10	1200
4245	Fassung für Lampen mit Sockel W2,1x9,5d · holder for bulbs with socket W2,1x9,5d · fiche pour ampoules avec culot W2,1x9,5d · socket para bombillas con base W2,1x9,5d Mit Kabel · with cable · avec cable · con cable	10	500
4144	Fassung für Lampen mit Sockel W2x4,6d · holder for bulbs with socket W2x4,6d · fiche pour ampoules avec culot W2x4,6d · socket para bombillas con base W2x4,6d Mit Kabel · with cable · avec cable · con cable	10	500



Mini Relais Sockel · Mini relay sockets · Culots pour relais mini · Portaréle para relés mini

Type	i			
	2222	Für alle Relais mit 6,3 mm Stecker · for all relays with 6,3 mm pins · pour tous les relais avec terminaux de 6,3 mm para todos los relés con 6,3 mm terminales	10	300
	222210	Mit 5 Kabel · with 5 cables · avec 5 cables · con 5 cables	1	100
	222205	Mit Pins · with pins · avec terminaux · con terminales	1	100
	2223	Für Hochleistungsrelais · for high power relays pour relais haute puissance · para relés de alta potencia	10	200
	222310	Mit 5 Kabel · with 5 cables · avec 5 cables · con 5 cables	1	100
	222305	Mit Pins · with pins · avec terminaux · con terminales	1	100
	2224	Für Hochleistungsrelais - Wechsler · for high power change over relays · pour relais inverseur haute puissance · para relé inductor de alta potencia	10	200
	222410	Mit 5 Kabel · with 5 cables · avec 5 cables · con 5 cables	1	100
	222405	Mit Pins · with pins · avec terminaux · con terminales	1	100

Mikro Relais Sockel · Micro relay sockets · Culots pour relais micro · Portarelé para relés micro

Type	i		
1122	Ohne Lasche · no bracket · sans patte · sin grapa	10	250
1123	Mit Lasche · with bracket · avec patte · con grapa	10	250
112310	Mit Kabel · with cable · avec cable · con cable	10	100
112305	Mit Pins · with pins · avec terminaux · con terminales	10	100

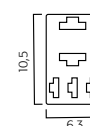
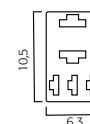
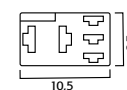

Hupen Adapter · Horn adapters · Adapteurs de klaxon · Adaptadores de bocina

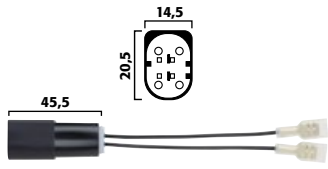

Type	i		
120010	Hupen Adapter von universell auf VW + Mercedes Horn adapter from universal plugs to VW + Mercedes Adapteur de klaxon de universal à VW + Mercedes Adaptador de bocina: de universal a VW + Mercedes	10	100

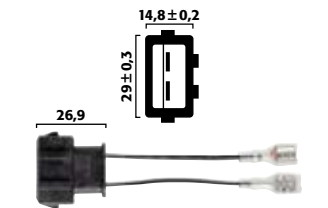

120011	Hupen Adapter von universell auf VW (älteres Modell) Horn adapter from universal plugs to VW (old type) Adapteur de klaxon de universal à VW (ancien modèle) Adaptador de bocina: de universal a VW (modelo antiguo)	10	100
--------	---	----	-----

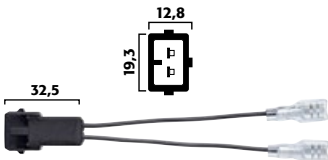

120020	Hupen Adapter von universell auf Peugeot Horn adapter from universal plugs to Peugeot Adapteur de klaxon de universal à Peugeot Adaptador de bocina: de universal a Peugeot	10	100
--------	--	----	-----

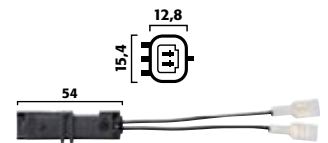

120021	Hupen Adapter von universell auf Peugeot (neueres Modell) Horn adapter from universal plugs to Peugeot (new type) Adapteur de klaxon de universal à Peugeot (modèle plus récent) Adaptador de bocina: de universal a Peugeot (modelo nuevo)	10	100
--------	--	----	-----

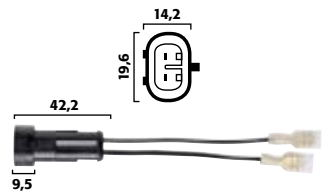

120030	Hupen Adapter von universell auf Jaguar Horn adapter from universal plugs to Jaguar Adapteur de klaxon de universal à Jaguar Adaptador de bocina: de universal a Jaguar	10	100
--------	--	----	-----

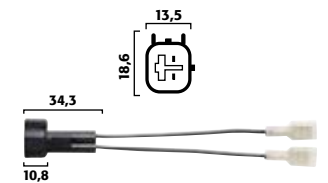

120040	Hupen Adapter von universell auf Ford Horn adapter from universal plugs to Ford Adapteur de klaxon de universal à Ford Adaptador de bocina: de universal a Ford	10	100
--------	--	----	-----

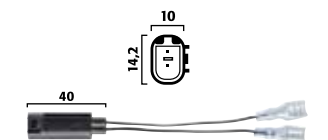

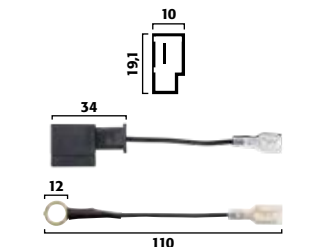

120050	Hupen Adapter von universell auf BMW Horn adapter from universal plugs to BMW Adapteur de klaxon de universal à BMW Adaptador de bocina: de universal a BMW	10	100
--------	--	----	-----



120060	Hupen Adapter von universell auf Toyota Horn adapter from universal plugs to Toyota Adapteur de klaxon de universal à Toyota Adaptador de bocina: de universal a Toyota	10	100
--------	--	----	-----

Ersatzteilkästen · Spare lamp kits · Coffrets de secours · Cajas de repuesto

Type	i			
8004	1x H4 625543 1x P21W 6671 1x R5W 4025 1x C5W 4033	1x PY21W 667101 Amber 1x P21/5W 5229 1x T4W 4088 2x 2148xx	1	36
8017	1x H1 3021 1x 6671 1x 5229 1x 4033 4x 2148xx	1x H7 2070 1x 667101 Amber 1x 4025 1x 429101	1	36
8007	1x H7 2070 1x P21W 6671 1x P21/5W 5229 1x W5W 4291	1x PY21W 667101 1x WY5W 429101 1x R5W 4025 2x 2148xx	1	36
8031	1x R2 3130 1x 4203 1x T4W 4089 1x 124816	1x P21W 6670 1x P21/5W 5228 1x 124808 1x R10W 14023	1	36
8032	1x S2 3131 1x 4203 1x T4W 4089 1x P21W 6670	1x 4050 1x P21/5W 5228 1x 124808 1x R10W 14023	1	36
8039	1x R2 3940 1x R10W 14025 1x P21/5W 5229 1x 124808	1x P21W 6671 1x 4231 1x T4W 4088 1x 124816	1	36



Andere Bestückung auf Anfrage · other fittings on request
autre équipement sur demande · otro contenido a demanda



Ersatzteilkästen · Spare lamp kits · Coffrets de secours · Cajas de repuesto





Type	i			
8204	1x H4 625543 1x R5W 4025 1x 214810 1x 214820	1x P21W 6671 1x T4W 4088 1x 214815	1	56
8201	1x H1 3021 1x R5W 4025 1x 214810 1x 214820	1x P21W 6671 1x W5W 4291 1x 214815	1	56
8207	1x H7 2070 1x R5W 4025 1x 214810 1x 214820	1x PY21W 667101 Amber 1x WY5W 429101 Amber 1x 214815	1	56
Andere Bestückung auf Anfrage · other fittings on request autre équipement sur demande · otro contenido a demanda				

Ersatzteilkästen für Lkw · Spare lamp kits for trucks
Coffrets de secours pour camions · Cajas de repuesto para camiones



Type	i			
8044	1x H4 825543 2x P21W 6652 1x T4W 4080 1x 214815	1x P21W/5W 5239 1x R5W 4052 1x C5W 4002 1x 214820	1	36
8405	2x H4 825543 2x P21/5W 5239 2x T4W 4080	4x P21W 6652 2x R5W 4052 2x C5W 4002 4x Flachsicherungen · blade fuses · fusibles plats · fusibles planos	1	20
8407	2x H7 2470 2x P21/5W 5239 2x T4W 4080	4x P21W 6652 2x R5W 4052 2x C5W 4002 4x Flachsicherungen · blade fuses · fusibles plats · fusibles planos	1	20
Andere Bestückung auf Anfrage · other fittings on request autre équipement sur demande · otro contenido a demanda				



Werkstattsortiment · Workshop kit
Assortiment pour ateliers de mécanique · Surtido para talleres

Type	i					
80200	assorted small bulbs				1	1
6924	12 V	0,5 W	W2x4,6d PVC	10		
449103	12 V	1,1 W	BX8,4d	10		
419101	12 V	1,2 W	B8,5d	10		
419102	12 V	1,2 W	B8,3d	10		
419103	12 V	1,2 W	BX8,4d	10		
449101	12 V	1,2 W	BX8,5d	10		
6925	12 V	1,2 W	W2x4,6d PVC	10		
479103	12 V	1,3 W	BX8,4d	10		
449105	14 V	1,4 W	HRQ	5		
459101	12 V	1,5 W	BX8,4d	10		
459103	12 V	1,5 W	BX8,4d	10		
183385	12 V	1,8 W	EBS	5		
439101	12 V	2 W	B8,5d	10		
439102	12 V	2 W	B8,3d	10		
439103	12 V	2 W	BX8,4d	10		
479101	12 V	2 W	BX8,5d	10		
409080	12 V	3 W	B10d Halogen	2		
4591	12 V	3 W	T6,5	10		



Sicherungssortiment · Fuse kit · Assortiment de fusibles · Surtido de fusibles



Type	i				
213050	Stecksicherungen · blade fuses fusibles plats · fusibles de enchufe			1	1
314820	32 V	20 A	Gelb · yellow	2	
314830	32 V	30 A	Grün · green	2	
314840	32 V	40 A	Orange · orange	2	
314850	32 V	50 A	Rot · red	2	
314860	32 V	60 A	Hellblau · light blue	2	
214805	32 V	5 A	Hellbraun · light brown	10	
214875	32 V	7,5 A	Brown · brown	10	
214810	32 V	10 A	Rot · red	10	
214815	32 V	15 A	Hellblau · light blue	10	
214820	32 V	20 A	Gelb · yellow	10	
214825	32 V	25 A	Weiß · white	10	
214830	32 V	30 A	Grün · green	10	
514875	32 V	7,5 A	Braun · brown	10	
514810	32 V	10 A	Rot · red	10	
514815	32 V	15 A	Hellblau · light blue	10	
514820	32 V	20 A	Gelb · yellow	10	
514825	32 V	25 A	Weiß · white	10	
514830	32 V	30 A	Grün · green	10	

Sicherungssortiment · Fuse kit · Assortiment de fusibles · Surtido de fusibles

Type	i				
213010	Kleine Stecksicherungen · small blade fuses fusibles plats miniatures · fusibles miniaturas de enchufe			1	1
514802	32 V	2 A	Grau · grey	10	
514803	32 V	3 A	Violett · violet	10	
514804	32 V	4 A	Rosa · pink	10	
514805	32 V	5 A	Hellbraun · light brown	10	
514875	32 V	7,5 A	Braun · brown	10	
514810	32 V	10 A	Rot · red	10	
514815	32 V	15 A	Hellblau · light blue	10	
514820	32 V	20 A	Gelb · yellow	10	
514825	32 V	25 A	Weiß · white	10	
514830	32 V	30 A	Grün · green	10	
16552	Greifzange für Stecksicherungen blade fuse puller pince des fusibles plats pinza para fusibles de enchufe			1	



Die Sicherungen entsprechen den Normen DIN 72581/3, SAE J2077, SAE J1284, SAE J1888, JASO D612 bzw. ISO DIS 8820-3.

fuses are in accordance with norms DIN 72581/3, SAE J2077, SAE J1284, SAE J1888, JASO D612 bzw. ISO DIS 8820-3.

les fusibles sont conformes à les normes DIN 72581/3, SAE J2077, SAE J1284, SAE J1888, JASO D612 bzw. ISO DIS 8820-3.

los fusibles son conforme a las normas DIN 72581/3, SAE J2077, SAE J1284, SAE J1888, JASO D612 bzw. ISO DIS 8820-3.

Sicherungssortiment · Fuse kit · Assortiment de fusibles · Surtido de fusibles



Type	i				
213020	Jap. Miniatursicherungen jap. miniature blade fuses fusibles plats miniatures type japonais fusibles miniaturas de enchufe tipo japónés			1	1
503802	58 V	2 A	Grau · grey	10	
503803	58 V	3 A	Violett · violet	10	
503804	58 V	4 A	Rosa · pink	10	
503805	58 V	5 A	Hellbraun · light brown	10	
503875	58 V	7,5 A	Braun · brown	10	
503810	58 V	10 A	Rot · red	10	
503815	58 V	15 A	Hellblau · light blue	10	
503820	58 V	20 A	Gelb · yellow	10	
503825	58 V	25 A	Weiß · white	10	
503830	58 V	30 A	Grün · green	10	
16552	Greifzange für Stecksicherungen blade fuse puller pince des fusibles plats pinza para fusibles de enchufe			1	

Sicherungssortiment · Fuse kit · Assortiment de fusibles · Surtido de fusibles

Type	i				
213040	Stecksicherungen · blade fuses fusibles plats · fusibles de enchufe			1	1
214801	32 V	1 A	Schwarz · black	5	
214802	32 V	2 A	Grau · grey	5	
214803	32 V	3 A	Violett · violet	10	
214804	32 V	4 A	Rosa · pink	10	
214805	32 V	5 A	Hellbraun · light brown	10	
214875	32 V	7,5 A	Braun · brown	10	
214810	32 V	10 A	Rot · red	10	
214815	32 V	15 A	Hellblau · light blue	10	
214820	32 V	20 A	Gelb · yellow	10	
214825	32 V	25 A	Weiß · white	10	
214830	32 V	30 A	Grün · green	10	
214840	32 V	40 A	Orange · orange	10	
16552	Greifzange für Stecksicherungen blade fuse puller pince des fusibles plats pinza para fusibles de enchufe			1	





Sicherungssortiment · Fuse kit · Assortiment de fusibles · Surtido de fusibles



Type	i				
213090	Stecksicherungen · blade fuses 10 spaces fusibles plats · fusibles de enchufe			1	1
214803	32 V	3 A	Violett · violet	5	
214805	32 V	5 A	Hellbraun · light brown	10	
214875	32 V	7,5 A	Braun · brown	5	
214810	32 V	10 A	Rot · red	20	
214815	32 V	15 A	Hellblau · light blue	15	
214820	32 V	20 A	Gelb · yellow	15	
214825	32 V	25 A	Weiß · white	5	
214830	32 V	30 A	Hellgrün · light green	5	
16552	Greifzange für Stecksicherungen blade fuse puller pince des fusibles plats pinza para fusibles de enchufe			1	



Sicherungssortiment · Fuse kit · Assortiment de fusibles · Surtido de fusibles

Type	i				
213080	Kleine Stecksicherungen · small blade fuses 10 spaces fusibles plats miniatures · fusibles miniaturas de enchufe			1	1
514803	32 V	3 A	Violett · violet	5	
514805	32 V	5 A	Hellbraun · light brown	10	
514875	32 V	7,5 A	Braun · brown	5	
514810	32 V	10 A	Rot · red	20	
514815	32 V	15 A	Hellblau · light blue	15	
514820	32 V	20 A	Gelb · yellow	15	
514825	32 V	25 A	Weiß · white	5	
514830	32 V	30 A	Grün · green	5	
16552	Greifzange für Stecksicherungen blade fuse puller pince des fusibles plats pinza para fusibles de enchufe			1	



Sicherungssortiment · Fuse kit · Assortiment de fusibles · Surtido de fusibles





Type	i				
213070	Stecksicherungen · blade fuses fusibles plats · fusibles de enchufe			1	1
514803	32 V	3 A	Violett · violet	5	
514805	32 V	5 A	Hellbraun · light brown	5	
514875	32 V	7,5 A	Braun · brown	5	
514810	32 V	10 A	Rot · red	20	
514815	32 V	15 A	Hellblau · light blue	20	
514820	32 V	20 A	Gelb · yellow	20	
514825	32 V	25 A	Weiß · white	15	
514830	32 V	30 A	Grün · green	20	
214805	32 V	5 A	Hellbraun · light brown	10	
214875	32 V	7,5 A	Braun · brown	10	
214810	32 V	10 A	Rot · red	30	
214815	32 V	15 A	Hellblau · light blue	30	
214820	32 V	20 A	Gelb · yellow	20	
214825	32 V	25 A	Weiß · white	20	
214830	32 V	30 A	Grün · green	20	
214840	32 V	40 A	Orange · orange	5	

Sicherungssortiment · Fuse kit · Assortiment de fusibles · Surtido de fusibles

Type	i				
314820	32 V	20 A	Gelb · yellow	8	
314830	32 V	30 A	Grün · green	8	
314840	32 V	40 A	Orange · orange	8	
314850	32 V	50 A	Rot · red	8	
314860	32 V	60 A	Hellblau · light blue	8	
314870	32 V	70 A	Braun · brown	8	
314880	32 V	80 A	Weiß · white	8	
3148100	32 V	100 A	Violett · violet	5	
503802	58 V	2 A	Grau · grey	5	
503803	58 V	3 A	Violett · violet	5	
503804	58 V	4 A	Pink · pink	5	
503805	58 V	5 A	Hellbraun · light brown	10	
503875	58 V	7,5 A	Braun · brown	15	
503810	58 V	10 A	Rot · red	20	
503815	58 V	15 A	Hellblau · light blue	20	
503820	58 V	20 A	Gelb · yellow	20	
503825	58 V	25 A	Weiß · white	15	
503830	58 V	30 A	Grün · green	15	

Verkaufsdisplays · Sales displays · Kits de vente · Exhibidores

Type	i		
18900	Metallwandschrank · metallic lamp cabinet présentoir de métal · armario metálico	1	1
183000	Mit Prüfgerät · including tester avec controleur de lampes con probador de bombillas		
			
Lieferung ohne Lampen · delivery without bulbs livraison sans ampoules · entrega sin bombillas			

MADE IN QUALITY







Produkt index
in numerischer Reihenfolge nach Typ

Product index
in numerical order by type



Indice de produits
dans l'ordre numérique par type

Indice de producto
en orden numérico po tipo



Product index



Fahrzeuglampen · Car bulbs · Ampoules pour véhicules · Lámparas para vehículos

Type	V	W		ECE	lm	B3	Tc		P.
606	6	0,6	E10	C0,6W					55
624	6	2,4	E10	C2,4W					55
660	6	6	E10		50 +-30%	100	300		55
880	12	27	PG13	H27W/1	447 +- 15%			T50=900	29
881	12	27	PGJ13	H27W/2	447 +- 15%			T50=900	29
885	12	50	PG13		1250 +-12%			B50=200	29
886	12	50	PGJ13		1250 +-12%			B50=200	29
890	12	27	PG13		540 +-12%			T50=300	29
893	12	37,5	PG13		940 +-12%	140	230	14V	29
894	12	37,5	PGJ13		940 +-12%	140	230	14V	29
896	12	37,5	PGJ13		940 +-12%	140	230	14V	29
921	12	16	W2,1x9,5d	W16W, T15					47
1151	12	25	P15s-25-1						34
1181	12	18/18	P15d-25-1						34
1251	12	25/25	P15d-25-1						34
1351	12	35/35	P15d-25-1						34
1421	12	3	BA15s						41
2000	12	15	P26s	S3	240 +- 15%	50	150		35
2001	12	20	P26s						35
2002	12	25	P26s						35
2038	12	4	BA9s		17,6 -32,7			500	43
2070	12	55	PX26d	H7	1500 +-10%	330	550		20

Product index





Fahrzeu­glampen · Car bulbs · Ampoules pour véhicules · Lámparas para vehículos

Type	V	W		ECE	lm	B3	Tc		P.
2080	12	35	PGJ19-1	H8	800 +-15%	400	800		22
2090	12	65	PGJ19-5	H9	2100 +-10%	300	500		22
2110	12	55	PGJ19-2	H11	1215-1485	800	1400		23
2114	24	70	PGJ19-2	H11	1600 +-10%	500	1000		23
2180	12	65	PY26d-1	H18					24
2190	12	21	W3x16d	W21W, T20	460 +-69			300	47
2251	12	25/25	P15d-25-1	M5	600/550 +-15%	150	300		31
2351	12	35/35	P15d-25-1	M5	750/750 +-15%	75/75	200/200		31
2353	12	35/35	P15d-25-3	M5	750/750 +-15%	75/75	200/200		31
2470	24	70	PX26d	H7	1750 +-10%	220	500		20
2690	12	21/5	W3x16q	W21/5W, T20	440 +-66/35 +-7			500/1000	47
3008	24	3	BA9s						42
3021	12	55	P14,5s	H1	1550 +-232	400	650		17
3024	24	70	P14,5s	H1	1900 +-15%	400	650		17
3038	12	3	BA9s		28 +-15%	250	500		42
3057	12,8	32/2 CP	W2,5y16q						39
3130	6	45/40	P45t	R2	720				34
3131	6	35/35	BA20d	S2	650/465 +-20%	100	250		35
3156	12	27	W2,5x16d	P27W		1200	5000		37
3157	12	27/7	W2,5x16q	P21/7W		1200	5000		39
3223	6	25/25	BA20d	S1	435/315 +-20%	100	250		35
3265	6	15/15	BA20d		250/190 +-20%	100	250		35



Product index



Fahrzeuglampen · Car bulbs · Ampoules pour véhicules · Lámparas para vehículos

Type	V	W		ECE	lm	B3	Tc		P.
3320	12	55	PK22s	H3	1450 +-218	400	650		19
3324	24	70	PK22s	H3	1750 +-15%	400	650		19
3329	12	35	BA20s	F2					34
3348	48	45	PK22s	H3	960 +-10%	204	229		19
3350	12	50	BA20s						34
3380	80	55	PK22s	H3	1050 +-15%	215	258		19
3420	12	55	X511	H2					18
3440	24	35	BA20s	F2					34
3720	24	70	X511	H2	1828-2472	90	250		18
3770	24	55/50	P45t	R2	1000	90	180		34
3923	12	25/25	BA20d	S1	435/315 +-20%	100	250		35
3939	12	35/35	BA20d	S2	650/465 +-20%	70	200		35
3940	12	45/40	P45t	R2	860	100	220		34
4000	24	15	P26s						35
4002	24	5	SV8,5	C5W	36-54			B50=200	52
4005	12	5	BA9s		12,5 +-15%	1000	1600		32
4006	12	6	BAX9s	H6W	125 +-12%	600	1000		32
4008	24	2	BA9s		19 +-15%	1000	1600		42
4010	12	10	BA9s		200 +-10%	300	600		32
4020	12	20	BA9s		470 +-10%	300	600		32
4023	6	5	BA15s	R5W	40-60			Tn=200	40
4025	12	5	BA15s	R5W	40-60	150	400		40

Product index





Fahrzeuqlampen · Car bulbs · Ampoules pour véhicules · Lámparas para vehículos

Type	V	W		ECE	lm	B3	Tc		P.
4032	6	5	SV8,5	C5W	45 +-20%	100	300		52
4033	12	5	SV8,5	C5W	36-54			Tn=200	52
4038	12	2	BA9s		12,5 +-15%	1000	1600		42
4039	6	2	BA9s						42
4043	6	2	E10						43
4045	12	3	E10					2000	43
4046	24	3	E10					2000	43
4048	24	3	BA7s		7,5-19,5			Tn=300	43
4049	6	0,6	BA7s						43
4050	6	1,2	BA7s						43
4051	12	2	BA7s		8,0-14,0			Tn=200	43
4052	24	5	BA15s	R5W	40-60	100	300		40
4071	12	21	BA15s		224-336	350	740		41
4080	24	4	BA9s	T4W	35 +-15%	500	1250		42
4085	12	5	BA9s		35 +-30%	150	500		43
4088	12	4	BA9s	T4W					42
4089	6	4	BA9s	T4W	28-42			Tn=300	42
4090	12	3	W2,1x9,5d	W3W	15,4-28,6	750	1500		45
4092	24	3	W2,1x9,5d	W3W	22 +-20%	400	3000		45
4096	6	3	W2,1x9,5d	W3W					46
4191	12	1,2	W2x4,6d	W1,2W	8	750	2500		44
4192	24	1,2	W2x4,6d	W1,2W	6,38 +-25%	400	2000		45



Product index



Fahrzeuglampen · Car bulbs · Ampoules pour véhicules · Lámparas para vehículos

Type	V	W		ECE	lm	B3	Tc		P.
4196	6	1,2	W2x4,6d	W1,2W					44
4203	6	10	SV8,5						54
4206	24	5	SV8,5		36-54			Tn=200	54
4210	24	10	SV8,5		76,5-103,5			Tn=200	54
4215	24	15	SV8,5		170-230			Tn=75	54
4218	24	18	SV8,5		240			Tn=75	54
4230	12	5	SV8,5		36-54			Tn=200	54
4231	12	10	SV8,5		100-150	400	800		54
4290	12	2	W2,1x9,5d	W2W	13,5 +-20%	500	1800		46
4291	12	5	W2,1x9,5d	W5W	40-60	600	1000		45
4292	24	5	W2,1x9,5d	W5W	50 +-20%	800	3000		45
4391	12	2	W2x4,6d		12 +-30%	300	1000		44
4425	12	5	BA15d	R5W	40-60	150	400		42
4452	24	5	BA15d	R5W	40-60	100	300		42
4490	12	10	W2,1x9,5d		120 +-14			400	46
4496	6	10	W2,1x9,5d		120 +-14			400	46
4590	12	3	W2x4,6d						45
4591	12	3	W2x4,6d		22 +-30%	80	200		45
4652	24	18	BA15s		250		400		36
4670	6	18	BA15s						36
4671	12	18	BA15s		250			B50=75	36
4691	12	2,3	W2x4,6d	W2,3W					44

Product index





Fahrzeuqlampen · Car bulbs · Ampoules pour véhicules · Lámparas para vehículos

Type	V	W		ECE	lm	B3	Tc		P.
4891	12	5	W2,1x9,5d	W5W	50 +-20%	1800	3600		33
5148	12	3	SV5,5		30 +-30%	50	150		51
5149	24	3	SV5,5		17,5 +-30%	50	150		51
5157	6	3	SV7						51
5158	12	3	SV7		30 +-30%	100	300		51
5159	24	3	SV7		17,5 +-30%			300	51
5168	12	10	SV8,5		105 +-30%			300	52
5209	12	18/5	BAY15d						38
5219	12	21/5	BA15d		440/35 +-15%	100/600	250/1600		39
5226	6	10/3	BAY15d						38
5227	12	10/5	BAY15d						38
5228	6	21/5	BAY15d	P21/5W	440 +-15%/35 +-20%	60/160	600/1600		38
5229	12	21/5	BAY15d	P21/5W	440/35 +-15%	100/600	250/1600		38
5230	12	32/4 CP	BAY15d		440/35 +-15%	100/600	250/1600		38
5239	24	21/5	BAY15d	P21/5W	440/40 +-15%	150/600	400/1600		38
5329	12	21/4	BAZ15d	P21/4W	374-506/12-18	250/600	480/2000		39
5339	24	21/4	BAZ15d	P21/4W	440/20 +-30%	60/160	600/1600		39
5671	12	15	BA15s		210			B50=75	36
5775	6	45/40	BA21d						35
6000	6	15	P26s	S3	240+-15%	40	110		35
6021	12	21	BAY9s	H21W	600 +-12%	250	500		32
6024	6	2,4	PX13,5s	HS3		250	500		55



Product index



Fahrzeuglampen · Car bulbs · Ampoules pour véhicules · Lámparas para vehículos

Type	V	W		ECE	lm	B3	Tc		P.
6127	6	1	SV5,5						51
6158	12	3	SV7		30 +-30%			150	51
6159	24	3	SV7						51
6251	6	25/25	P15d-25-1						34
6421	24	21	BA9s	H21W	600 +-12%	200	400		32
6441	24	1	W2x4,6d						50
6640	24	45	BA15s	Form U					34
6652	24	21	BA15s	P21W	391-529	350	750		36
6670	6	21	BA15s	P21W	460 +-15%			100	36
6671	12	21	BA15s	P21W	391-529	350	740		36
6674	12	21	BA15d		391-529	350	740		37
6678	12	21	BAU15s		280 +-20%	120	320		37
6743	24	45/40	BA20d		860/675 +-20%	100	250		35
6776	12	45/40	BA21d						35
6924	12	0,5	W2x4,6d						50
6925	12	1,2	W2x4,6d						50
8652	24	25	BA15s						36
8671	12	25	BA15s						36
9003	12	60/55	P43t	HB2 (US H4)	1650/1000 +-15%	250/400	500/900		14
9004	12	65/45	P29t	HB1	1200/700			173/368	25
9005	12	60	P20d	HB3	1860 +-12%	330	700		26
9006	12	51	P22d	HB4	1095 +-15%	1000	2200		27

Product index





Fahrzeu­glampen · Car bulbs · Ampoules pour véhicules · Lámparas para vehículos

Type	V	W		ECE	lm	B3	Tc		P.
9007	12	65/55	PX29t	HB5	1350/1000 +-15%	50/100	150/250	14V	28
9008	12	60/55	P26,4t	H13	1700/1100		320/1600	B10=150/1200	24
9011	12	65	PX20d	HIR1	2500 +-15%	220	300		28
9012	12	55	PX22d	HIR2	1875 +-15%	500	900		28
9055	12	53	PZ20d	H12					24
9076	12	70	P22d	HB4 Rally	1650 +-15%	80	180	14V	27
9086	12	80	P22d	HB4 Super Rally	2000 +-15%	80	180	14V	27
9104	12	100/80	P29t	HB1 Rally	1600/1300			86/173	25
9105	12	100	P20d	HB3 Rally	2650 +-12%	40	100		26
9107	12	100/80	PX29t	HB5 Rally	2000/1600 +-15%	50/100	150/300	14V	28
9108	12	100/80	P26,4t	H13 Rally	1500/1000	260/350	1450/1900		24
9145	12	42	PY20d	H10	850 +-15%	1500	2800		22
9629	48	25/10	BAY15d						38
9671	48	25	BA15s						36
9921	12	16	W2,1x9,5d	W16W, T15					47
12070	12	80	PX26d	H7 Rally	1900 +-10%	150	300		21
12080	12	65	PGJ19-1	H8 Rally	1730	700	1000		22
12110	12	90	PGJ19-2	H11 Rally	1961	200	400		23
13020	12	100	P14,5s	H1 Rally	2210-2990			Tn=100	18
13024	24	100	P14,5s	H1 Rally					18
13130	12	130	P14,5s	H1 Super Rally					18
13320	12	100	PK22s	H3 Rally					19



Product index



Fahrzeuglampen · Car bulbs · Ampoules pour véhicules · Lámparas para vehículos

Type	V	W		ECE	lm	B3	Tc		P.
13324	24	100	PK22s	H3 Rally					19
13330	12	130	PK22s	H3 Super Rally	1800 +-10%	487	532		19
13420	12	100	X511	H2 Rally					18
14023	6	10	BA15s	R10W	100-150			B50 = 200	41
14025	12	10	BA15s	R10W	100-150	300	600		41
14052	24	10	BA15s	R10W	100-150	200	500		41
14425	12	10	BA15d	R10W	100-150	300	600		42
14452	24	10	BA15d	R10W	100-150	200	500		42
15025	12	15	BA15s						41
24540	12	45/40	BA20d		860/675 +-20%	100	250		35
27140	24	30 mA	W2x4,6d	T5					45
27141	24	1	W2x4,6d	T5					45
40722	12	25	Pk32d-7	D5S	2000 + 300 - 200	2500	4000		13
40822	42	25	Pk32d-1	D8S	2000 +- 300	2500	4000		13
42322	42	35	Pk32d-5	D3S	3200 +- 450	1500	2500		12
42326	42	35	Pk32d-6	D3R	2800 +- 450	1500	2500		12
42422	42	35	P32d-5	D4S	3200 +- 450	2000	3000		12
42426	42	35	P32d-6	D4R	2800 +- 450	1500	2500		13
42522	42	35	Pk32d-5	D3S	3200 +- 450	1500	2500		12
85409	85	35	Pk32d-3	D1R	2800 +- 450	2000	3000		12
85410	85	35	Pk32d-2	D1S	3200 +- 450	2000	3000		12
85422	85	35	P32d-2	D2S	3400 +- 450	1500	2500		12

Product index





Fahrzeuqlampen · Car bulbs · Ampoules pour véhicules · Lámparas para vehículos

Type	V	W		ECE	lm	B3	Tc		P.
85426	85	35	P32d-3	D2R	2800 +-250	1500	2500		13
85510	85	35	Pk32d-2	D1S	3200 +-450	1500	2500		12
85522	85	35	P32d-2	D2S	3100 +-250	1500	2500		12
85526	85	35	P32d-3	D2R	2700 +-250	1500	2500		13
92070	12	55	PX26d	H7	1500 +-10%	330	550		20
92080	12	35	PGJ19-1	H8	800 +-15%	400	800		22
92090	12	65	PGJ19-5	H9	2100 +-10%	300	500		22
92107	12	16	W2,1x9,5d	WY16W					47
92110	12	55	PGJ19-2	H11	1215-1485	800	1400		23
92190	12	21	W3x16d	W21W T20	460 +-69			300	47
92690	12	21/5	W3x16q	W21/5W T20	440 +-66/35 +-7			500/1000	47
93021	12	55	P14,5s	H1	1550 +-232	400	650		17
93156	12	27	W2,5x16d	P27W		1200	5000		37
93157	12	27/7	W2,5x16q	P21/7W		1200	5000		39
93320	12	55	PK22s	H3	1450 +-218	400	650		19
93939	12	35/35	BA20d	S2	650/465 +-20%	70	200		35
94025	12	5	BA15s	R5W	40-60	150	400		40
94033	12	5	SV8,5	C5W	36-54			Tn=200	52
94088	12	4	BA9s	T4W					42
94191	12	1,2	W2x4,6d	T5	6			B50= 1000	44
94231	12	10	SV8,5		100-150	400	800		54
94291	12	5	W2,1x9,5d	W5W	40-60	600	1000		45



Product index



Fahrzeuglampen · Car bulbs · Ampoules pour véhicules · Lámparas para vehículos

Type	V	W		ECE	lm	B3	Tc		P.
95229	12	21/5	BAY15d	P21/5W	440/35 +-15%	100/600	250/1600		38
96671	12	21	BA15s	P21W	391-529	350	740		36
99004	12	65/45	P29t	HB1	1200/700				25
99005	12	60	P20d	HB3	1860 +-12%				26
99006	12	51	P22d	HB4	1095 +-15%	1000	2200		27
99007	12	65/55	PX29t	HB5	1350/1000 +-15%	50/100	150/250	14V	28
181471	24	1,2	EBS R6		7,5 +-30%	500	1000		49
181649	12	1,2	SG8-5,5d						50
181791	24	1,2	EBS R4						49
183385	12	1,8	EBS R11		6,5 +-30%	500	1500		49
183527	24	1,2	EBS R10						49
188328	24	1,2	EBS N10		7,5 +-30%	500	1000		49
191219	12	19	PGJ19-3	H16	500 +-10%	1150	2000		24
200033	12	15	P26s	S3					35
207022	12	55	PX26d	H7	1500 +-10%	500	1000		20
211022	12	55	PGJ19-2	H11	1350 +-10%	1000	2000		23
219007	12	21	WX3x16d	WY21W, T20	280 +-56			300	47
225112	12	25/25	P15d-25-1	M5	600/550 +- 15%	150	300		31
235112	12	35/35	P15d-25-1	M5	750/750 +-15%	75/75	200/200		31
235312	12	35/35	P15d-25-3	M5	750/750 +-15%	75/75	200/200		31
247022	24	70	PX26d	H7	1750 +-10%	500	1000		20
269007	12	21/5	W3x16q	W21/5W, T20	270 +-81 / 20 +-6			500/1000	47

Product index





Fahrzeuqlampen · Car bulbs · Ampoules pour véhicules · Lámparas para vehículos

Type	V	W		ECE	lm	B3	Tc		P.
302122	12	55	P14,5s	H1					17
302422	24	70	P14,5s	H1	1900 +-15%	600	1200		17
315601	12	27	W2,5x16d						37
315701	12	27/7	WX2,5x16q	PY21/7W		1200	5000		39
323023	12	35/30	P23t	HS5	620/515 +-12%	250	500		30
323543	12	35/35	PX43t	HS1	825/525 +-15%	100/200	200/400		30
332422	24	70	PK22s	H3	1680 +-10%	587	632		19
375701	12,8	2,1/0,59 A	WX2,5x16q						39
377002	24	75/75 CP	P45t		1000	90	180		34
392380	12	25/25	BA20d		600/550 +-15%	150	300		30
393980	12	35/35	BA20d	S2	750/550 +-15%	150	300		30
394002	12	75/75 CP	P45t		860	100	220		34
400115	6	15	SV8,5						54
400118	6	18	SV8,5						54
400210	24	10	SV8,5		105 +-30%		300		53
400233	24	5	SV8,5						53
400415	12	15	SV8,5		197-267	40	75		54
400418	12	18	SV8,5		240			Tn=75	54
400421	12	21	SV8,5	C21W					54
400601	12	6	BAZ9s	HY6W	75 +-17%	400	800		32
400633	12	6	BAX9s	H6W	125 +-12%	250	500		32
402509	12	5	BA15s						40



Product index



Fahrzeuglampen · Car bulbs · Ampoules pour véhicules · Lámparas para vehículos

Type	V	W		ECE	lm	B3	Tc		P.
403310	12	10	SV8,5		105 +-30%		300		53
403333	12	5	SV8,5						53
403334	12	5	SV8,5						53
405233	24	5	BA15s						40
405299	24	5	BA15s	R5W	50 +-15%	400	1000		40
408035	24	4	BA9s						43
408099	24	4	BA9s	T4W	35 +-15%	500	1250		42
408835	12	4	BA9s						43
409080	12	3	B10d		20 +-30%	300	1000		50
419101	12	1,2	B8,5d		6,38 +-25%	500	1000		48
419102	12	1,2	B8,3d						48
419103	12	1,2	BX8,4d		7,5 +-20%	600	3000		49
419104	12	1,2	B8,7d						50
419106	12	1,2	W2x4,6d	T5					44
419122	12	1,2	W2x4,6d	T5					44
419201	24	1,2	B8,5d		6,38 +-25%	400	2000		48
419202	24	1,2	B8,3d						48
419301	24	1,2	BX8,5d		6,38 +-25%	400	2000		48
429101	12	5	W2,1x9,5d	WY5W	24-36	1500	3000		45
429122	12	5	W2,1x9,5d	W5W T10 LL	50 +-20%	850	2000		45
429133	12	5	W2,1x9,5d	W5W	50 +-20%	100	300		45
429180	12	5	B10d						50

Product index





Fahrzeuqlampen · Car bulbs · Ampoules pour véhicules · Lámparas para vehículos

Type	V	W		ECE	lm	B3	Tc		P.
429235	24	5	W2,1x9,5d	T10					46
439101	12	2	B8,5d		10,2 +-25%	1300	4000		48
439102	12	2	B8,3d						48
439103	12	2	BX8,4d						49
439104	12	1 CP	B11d-T7						50
449007	12	10	W2,1x9,5d	T13	75 +-30%	100	300		46
449101	12	1,2	BX8,5d		6,38 +-25%	500	2000		48
449103	12	1,1	BX8,4d		3,55 +-25%	500	5000		49
449105	12	1,4	HRQ						50
459101	12	1,5	BX8,5d		6 +-20%	1000	6500		48
459103	12	1,5	BX8,4d		6,5 +-20%	1700	6500		49
469101	12	2,3	W2x4,6d	WY2,3W					44
479101	12	2	BX8,5d						48
479103	12	1,3	BX8,4d		6,5 +-20%	1300	6000		49
489133	12	5	W2,1x9,5d	W5W					33
516835	12	10	SV8,5						52
522902	12	21/5	BAW15d	PR21/5W	105/8 +-20%	450/800	1000/2000		39
522907	12	21/5	BAY15d		216-324/20-34	250/1000	480/2000		38
525543	12	100/55	P43t	H4 Rally					15
551523	12	55/15	PGJ23-1	H15	1350/260 +-10%	250/2000	500/4000		24
602023	24	60/20	PGJ23-1	H15	1350/260 +-10%	250/2000	500/4000		24
602101	12	21	BAW9s	HY21W	300 +-17%	200	400		32



Product index

Fahrzeuglampen · Car bulbs · Ampoules pour véhicules · Lámparas para vehículos



Type	V	W		ECE	lm	B3	Tc		P.
625522	12	60/55	P43t	H4	1403-1897/850-1150	900	1600		14
625536	12	60/55	P36t	H4	1650/1000 +-25%	150	400		16
625543	12	60/55	P43t	H4	1650/1000 +-15%	250/400	500/900		14
625545	12	60/55	P45t	H4	1650/1000	350	700		16
665201	24	21	BAU15s	PY21W	224-336	890	1590		37
665207	24	21	BA15s		391-529	350	750		36
665299	24	21	BA15s	P21W	391-529	150	350		36
667101	12	21	BAU15s	PY21W	224-336	890	1590		37
667102	12	21	BAW15s	PR21W	110 +-20%	250	600		37
667107	12	21	BA15s		224-336	350	740		36
667133	12	21	BA15s						36
725543	12	100/90	P43t	H4 Rally	2900/1700	80	200		15
725545	12	100/90	P45t	H4 Rally	2900/1700	80	200		16
825522	24	75/70	P43t	H4	1615-2185/1020-1380	340/800	700/1600		14
825543	24	75/70	P43t	H4	1900/1200 +-15%	180	500		14
825545	24	75/70	P45t	H4	1900/1200 +-15%	180	500		16
912070	12-24	26	PX26d	H7 LED	2400				72
912110	12	26	PGJ19-2	H11 LED	2400				72
912190	12		W3x16d	W21W LED	250 +-20%		29200*		77
912197	12		WX3x16d	WY21W LED	250 +-20%		29200*		77
912198	12		W3x16d	W21W LED	80 +-20%		29200*		77
912690	12		W3x16q	W21/5W LED	250/65 +-20%		29200*		77

*10y at 8h days

Product index



Fahrzeuqlampen · Car bulbs · Ampoules pour véhicules · Lámparas para vehículos



Type	V	W		ECE	lm	B3	Tc		P.
912697	12		W3x16q	WY21/5W LED	50/150 +-20%		29200*		77
912698	12		W3x16q	W21/5W LED	60/20 +-20%		29200*		77
913021	12-24	24	P14,5s	H1 LED	2400				72
913320	12	26	PK22s	H3 LED	2400				72
914020	12-24		BA15s	R5W LED			29200*		74
914025	12	10	BA15s	R10W	100-150	300	600		41
914028	12-24		BA15s	R5W LED			29200*		74
914030	12-24		SV8,5	C5W LED				17520	74
914031	12-24		SV8,5	C5W LED				17520	74
914231	12-24		SV8,5	K type LED				17520	74
914290	12-24		W2,1x9,5d	W5W LED			29200*		75
914293	12-24		W2,1x9,5d	W5W LED			29200*		75
915168	12-24		SV8,5	5168 type LED				17520	74
915220	12		BAY15d	P21/5W LED			29200*		76
915227	12		BAY15d	P21/5W LED			29200*		76
915228	12		BAY15d	P21/5W LED			29200*		76
915238	24		BAY15d	P21/5W LED			29200*		76
915239	24		BAY15d	P21/5W LED			29200*		76
916652	24		BA15s	P21W LED			29200*		75
916658	24		BA15s	P21W LED			29200*		75
916670	12-24		BA15s	P21W LED			29200*		75
916677	12		BA15s	P21W LED			29200*		75

*10y at 8h days



Product index

Fahrzeuglampen · Car bulbs · Ampoules pour véhicules · Lámparas para vehículos



Type	V	W		ECE	lm	B3	Tc		P.
916678	12		BA15s	P21W LED			29200*		75
919006	12	26	P22d	HB4 LED	2400				72
919005	12	26	P20d	HB3 LED	2400				72
925543	12	130/90	P43t	H4 Super Rally	3600/1900 +- 15%	40	100		15
925545	12	130/90	P45t	H4 Super Rally	3600/1900 +- 15%	40	100		16
1332033	12	100	PK22s	H3 Rally	985 +- 10 %	479	504		19
1402501	12	10	BAU15s	RY10W	75 +- 10 %	400	1000		41
1402507	12	10	BA15s		100-150	300	600		40
1402533	12	10	BA15s						40
1405299	24	10	BA15s	R10W	125 +-15 %	400	1000		41
2070110	12	55	PX26d	H7	1350-1650	125	250		20
2070130	12	55	PX26d	H7	1500 +-10%	150	250		21
2070180	12	55	PX26d	H7	1350-1650	175	350		21
2070260	12	55	PX26d	H7	1500 +-10%	150	250		21
2070300	12	55	PX26d	H7	1350-1650	125	250		20
2070333	12	55	PX26d	H7	1500 +-10%	180	400		20
2070335	12	70	PX26d	H7 Rally	900 +-15%	200	400		21
2070500	12	55	PX26d	H7	1350-1650	125	250		20
2070600	12	55	PX26d	H7	1350-1650	125	250		20
2070666	12	55	PX26d	H7	1500 +-10%	330	550		21
2070670	12	70	PX26d	H7 Rally	900 +-15%	200	400		21
2070680	12	55	PX26d	H7	1500 +-10%	300	500		20

*10y at 8h days

Product index





Fahrzeuqlampen · Car bulbs · Ampoules pour véhicules · Lámparas para vehículos

Type	V	W		ECE	lm	B3	Tc		P.
2070890	12	55	PX26d	H7	1500 +-10%	300	500		20
2070900	12	55	PX26d	H7	1350-1650	175	350		20
2074210	12	10	G4						33
2074220	12	20	G4						33
2074410	24	10	G4						33
2074420	24	20	G4						33
2080335	12	50	PGJ19-1	H8 Rally	1250 +-10%	350	450		22
2110110	12	55	PGJ19-2	H11	1215-1485	125	250		23
2110130	12	55	PGJ19-2	H11	1350 +-10%	150	250		23
2110260	12	55	PGJ19-2	H11	1350 +-10%	150	250		23
2110333	12	55	PGJ19-2	H11	1246 +-10%	400	850		23
2110335	12	70	PGJ19-2	H11 Rally	658	300	500		23
2110500	12	55	PGJ19-2	H11	1215-1485	125	250		23
2110900	12	55	PGJ19-2	H11	1215-1485	175	350		23
3021110	12	55	P14,5s	H1	1318-1782	125	250		17
3021130	12	55	P14,5s	H1	1550 +-15%	150	300		18
3021180	12	55	P14,5s	H1	1318-1782	175	350		17
3021260	12	55	P14,5s	H1	1550 +-15%	150	300		18
3021333	12	55	P14,5s	H1	1550 +-15%	200	350		17
3021335	12	70	P14,5s	H1 Rally	870 +-10%	457	518		18
3021500	12	55	P14,5s	H1	1318-1782	125	250		17
3021670	12	70	P14,5s	H1 Rally	870 +-10%	457	518		18



Product index



Fahrzeuglampen · Car bulbs · Ampoules pour véhicules · Lámparas para vehículos

Type	V	W		ECE	lm	B3	Tc		P.
3021680	12	55	P14,5s	H1					17
3021890	12	55	P14,5s	H1					17
3021900	12	55	P14,5s	H1	1318-1782	175	350		17
3235333	12	35/35	PX43t	HS1					30
3320333	12	55	PK22s	H3	1280 +-10%	680	722		19
3320335	12	70	PK22s	H3 Rally	850 +-10%	462	504		19
3320666	12	55	PK22s	H3	1240 +-10%	652	714		19
3320900	12	55	PK22s	H3	1450 +-15%	150	300		19
6213043	12	60/55	P43t	H4	1650/1000 +-15%	40/130	80/200		15
6255180	12	60/55	P43t	H4	1403-1897/850-1150	125/175	250/350		14
6255260	12	60/55	P43t	H4	1650/1000 +-15%	40/130	80/200		15
6255333	12	60/55	P43t	H4	1650/1000 +-15%	250/400	500/900		14
6255666	12	60/55	P43t	H4	1650/1000 +-15%				14
6290043	12	60/55	P43t	H4	1403-1897/850-1150	125/175	250/350		14
7255333	12	100/90	P43t	H4 Rally					15
7255666	12	100/90	P43t	H4 Rally	2900/1500 +-15%				15
8213043	24	130/90	P43t	H4 Super Rally	3000-4000/1440-1760	450	900		15
8290043	24	100/90	P43t	H4 Rally	1880-2820/1250-1691	80	200		15
8290045	24	100/90	P45t	H4 Rally	1880-2820/1250-1691	80	200		16
9003333	12	60/55	P43t	H4	1650/1000 +-15%	250/400	500/900		14
9004100	12	65/45	P29t	HB1					25
9004333	12	65/45	P29t	HB1	1200/700			92/230	25

Product index





Fahrzeu­glampen · Car bulbs · Ampoules pour véhicules · Lámparas para vehículos

Type	V	W		ECE	lm	B3	Tc		P.
9004777	12	65/45	P29t	HB1					25
9005333	12	60	P20d	HB3	1860 +-12%	330	700		26
9005900	12	60	P20d	HB3	1637-2038	100	200		26
9006333	12	51	P22d	HB4	1095 +-15%	120	250		27
9006335	12	60	P22d	HB4 Rally	658	300	500		27
9006900	12	51	P22d	HB4	1095 +-15%	150	360		27
9007333	12	65/55	PX29t	HB5					28
9104333	12	100/80	P29t	HB1 Rally	1400/1100			86/173	25
9210043	12	130/100	P43t	H4 Super Rally	3600 +-15%	40	100		15
9625543	12	60/55	P43t	H4	1650/1000 +-15%	250/400	500/900		14
9667101	12	21	BAU15s	PY21W	224-336	890	1590		37
9725543	12	100/90	P43t	H4 Rally	2900/1700	80	200		15
38874933	12	26	PG18.5d-3	PSX26W	500 +-10%	3000	6000		60
38965433	12	16	PU20d/2	HPC16WY	180 +-20%	1200	2400		58
39196133	12	24	WP3,3x14,5/3	PW24W	500 +-10%	750	1500		59
39200533	12	24	WP3,3x14,5/4	PWY24W SV	300 +-15%	1000	2000		59
39202933	12	24	WP3,3x14,5/4	PWY24W	300 +-15%	1200	2400		59
39398033	12	35/35	BA20d		420/300 +-15%	150	250		30
39621860	13,5	24	Hiper LCP HTR HPSL2A						59
39623230	12	16	WP3,3x14,5/4	PW16W	300 +-15%	1500	3000		59
52735233	12	19	PG20/2	PSY19W	215			2400	60
6289043	12	60/55	P43t	H4 Mega +50%	1650 /1000	380	635		14



Product index



Fahrzeuglampen · Car bulbs · Ampoules pour véhicules · Lámparas para vehículos

Type	V	W		ECE	lm	B3	Tc		P.
69653033	12	19	PG20/1	PS19W	350			2300	60
69668433	12	24	PG20/4	PSY24W	300			2400	60
69672133	12	13	PG18.5-d1	P13W	250			8000	60
69676933	12	24	PG20/7	PSX24W	500			1500	61
69678333	12	24	PGU20/4	PY24W SV	300			2000	61
69690533	12	24	PGU20/4	PY24W	300			2400	61
70044233	12	24	PG20/3	PS24W FF	500 +-10%	750	1500		61
70379533	12	24	PG20/4	PSY24W SV+	300			2000	61
77715934	12	16	PU20d/1	HPC16W	300 +-10%	1500	3000		58
77715941	12	19	PU20d/3	HPC19W	350 +-15%	1000	2000		58
77715958	12	24	PU20d/6	HPC24WY	300 +-15%	1200	2400		58
91191219	12	26	PGJ19-3	H16 LED	2400				72
91402501	12	10	BAU15s	RY10W	75 +-10%	400	1000		80
91625543	12-24	26	P43t	H4 LED	2400				72
92070900	12	55	PX26d	H7	1350-1650	175	350		20
92110900	12	55	PGJ19-2	H11	1215-1485	175	350		23
93021900	12	55	P14,5s	H1	1318-1782	175	350		17
93320900	12	55	PK22s	H3	1450 +-15%	150	300		19
96290043	12	60/55	P43t	H4	1403-1897/850-1150	125/175	250/350		14
99005900	12	60	P20d	HB3	1637-2038	100	200		26
99006900	12	51	P22d	HB4	1095 +-15%	150	360		27
2080B	12	35	PGJY19-1	H8B	800 +-15%	310	620		22

Product index



Fahrzeuglampen · Car bulbs · Ampoules pour véhicules · Lámparas para vehículos

Type	V	W		ECE	lm	B3	Tc		P.
2090B	12	65	PGJY19-5	H9B	2100 +-10%	250	500		22
2110B	12	55	PGJ19-2	H11B	1350 +-10%	350	580		23
211-2	12,8	12 CP	Miniature Cap		151			1000	55
6255PU43	12	60/55	PU43t-3	H19	1750 +- 10%	300/800	600/1600		25
6671SV	12	21	BAU15s	PY21W	280 +-20%	250	500		37
795X	12	50	BA15s		1250 +-15%	100	200		33
9005XS	12	60	P20d	HB3A	1860 +-12%	250	500		26
9006XS	12	51	P22d	HB4A	1095 +-12%	1000	1700		27
91M2070	12	20	PX26d	H7 Mini LED	1800				73
91M3021	12	18	P14,5s	H1 Mini LED	1600				73
91M625543	12	20	P43t	H4 Mini LED	1600/1300				73
H1CAN-BUS12	12			CANBUS H1					73
H1CAN-BUS24	24			CANBUS H1					73
H7CAN-BUS12	12			CANBUS H7					73
H7CAN-BUS24	24			CANBUS H7					73



Product index

Sicherungen · Fuses · Fusibles · Fusibles

Type	V	A	i	P.
3201	32	1	Glass fuses, 6,3x32 mm	94
3203	32	3	Glass fuses, 6,3x32 mm	94
3204	32	4	Glass fuses, 6,3x32 mm	94
3205	32	5	Glass fuses, 6,3x32 mm	94
3210	32	10	Glass fuses, 6,3x32 mm	94
3215	32	15	Glass fuses, 6,3x32 mm	94
3220	32	20	Glass fuses, 6,3x32 mm	94
3225	32	25	Glass fuses, 6,3x32 mm	94
3230	32	30	Glass fuses, 6,3x32 mm	94
3240	32	40	Glass fuses, 6,3x32 mm	94
38030	32	30	Fuse strips	99
38040	32	40	Fuse strips	99
38050	32	50	Fuse strips	99
38060	32	60	Fuse strips	99
38080	32	80	Fuse strips	99
38100	32	100	Fuse strips	99
39030	32	30	Type HSB	99
39040	32	40	Type HSB	99
39050	32	50	Type HSB	99
39060	32	60	Type HSB	99
39080	32	80	Type HSB	99
39100	32	100	Type HSB	99

Type	V	A	i	P.
39110	32	110	Type HSB	99
39125	32	125	Type HSB	99
39150	32	150	Type HSB	99
39175	32	175	Type HSB	99
124805	32	5	Thermoplastic fuses, yellow	95
124808	32	8	Thermoplastic fuses, white	95
124816	32	16	Thermoplastic fuses, red	95
124825	32	25	Thermoplastic fuses, blue	95
124840	32	40 (25)	Thermoplastic fuses, black	95
214800	32		Blade fuses assorted, Blister	86
214801	32	1	Blade fuses, black	86
214802	32	2	Blade fuses, grey	86
214803	32	3	Blade fuses, violet	86
214804	32	4	Blade fuses, pink	86
214805	32	5	Blade fuses, light brown	86
214810	32	10	Blade fuses, red	86
214815	32	15	Blade fuses, light blue	86
214820	32	20	Blade fuses, yellow	86
214825	32	25	Blade fuses, white	86
214830	32	30	Blade fuses, light green	86
214835	32	35	Blade fuses, dark green	86
214840	32	40	Blade fuses, orange	86



Product index

Sicherungen · Fuses · Fusibles · Fusibles

Type	V	A	i	P.
214875	32	7,5	Blade fuses, brown	86
284801	80	1	80 V blade fuses, black	87
284802	80	2	80 V blade fuses, grey	87
284803	80	3	80 V blade fuses, violet	87
284804	80	4	80 V blade fuses, pink	87
284805	80	5	80 V blade fuses, light brown	87
284810	80	10	80 V blade fuses, red	87
284815	80	15	80 V blade fuses, blue	87
284820	80	20	80 V blade fuses, yellow	87
284825	80	25	80 V blade fuses, natural	87
284830	80	30	80 V blade fuses, green	87
284840	80	40	80 V blade fuses, orange	87
284875	80	7,5	80 V blade fuses, brown	87
313820	32	20	Big compact blade fuses, yellow	88
313825	32	25	Big compact blade fuses, white	88
313830	32	30	Big compact blade fuses, light green	88
313835	32	35	Big compact blade fuses, dark green	88
313840	32	40	Big compact blade fuses, orange	88
313850	32	50	Big compact blade fuses, red	88
313860	32	60	Big compact blade fuses, blue	88
314820	32	20	Big blade fuses, yellow	88
314825	32	25	Big blade fuses, grey	88

Type	V	A	i	P.
314830	32	30	Big blade fuses, green	88
314840	32	40	Big blade fuses, orange	88
314850	32	50	Big blade fuses, red	88
314860	32	60	Big blade fuses, light blue	88
314870	32	70	Big blade fuses, brown	88
314880	32	80	Big blade fuses, white	88
315805	32	5	MB fuses, 6 Pins, orange	101
315875	32	7,5	MB fuses, 6 Pins, brown	101
316801		100, 30	MSB Type A	101
316802		70, 100	MSB Type A	101
316803		70, 120	MSB Type A	101
316804		100, 40	MSB Type A	101
316805		120, 40	MSB Type A	101
316806		120, 60	MSB Type A	101
316807		100, 60	MSB Type A	101
316808		60, 50	MSB Type A	101
316809		80, 50	MSB Type A	101
316810		80, 70	MSB Type A	101
501805	32	5	Micro III blade fuses, light brown	91
501810	32	10	Micro III blade fuses, red	91
501815	32	15	Micro III blade fuses, light blue	91
501875	32	7,5	Micro III blade fuses, brown	91



Product index

Sicherungen · Fuses · Fusibles · Fusibles

Type	V	A	i	P.
502803	32	3	Micro II blade fuses, violet	91
502804	32	4	Micro II blade fuses, pink	91
502805	32	5	Micro II blade fuses, light brown	91
502810	32	10	Micro II blade fuses, red	91
502815	32	15	Micro II blade fuses, light blue	91
502820	32	20	Micro II blade fuses, yellow	91
502825	32	25	Micro II blade fuses, white	91
502830	32	30	Micro II blade fuses, green	91
502875	32	7,5	Micro II blade fuses, brown	91
503802	58	2	Low profile small blade fuses, grey	90
503803	58	3	Low profile small blade fuses, violet	90
503804	58	4	Low profile small blade fuses, pink	90
503805	58	5	Low profile small blade fuses, light brown	90
503810	58	10	Low profile small blade fuses, red	90
503815	58	15	Low profile small blade fuses, light blue	90
503820	58	20	Low profile small blade fuses, yellow	90
503825	58	25	Low profile small blade fuses, white	90
503830	58	30	Low profile small blade fuses, green	90
503875	58	7,5	Low profile small blade fuses, brown	90
513800	58		Low profile small blade fuses, assorted, Blister	90
514800	32		Small blade fuses, assorted, Blister	89
514801	32	1	Small blade fuses, black	89

Type	V	A	i	P.
514802	32	2	Small blade fuses, grey	89
514803	32	3	Small blade fuses, violet	89
514804	32	4	Small blade fuses, pink	89
514805	32	5	Small blade fuses, light brown	89
514810	32	10	Small blade fuses, red	89
514815	32	15	Small blade fuses, light blue	89
514820	32	20	Small blade fuses, yellow	89
514825	32	25	Small blade fuses, white	89
514830	32	30	Small blade fuses, green	89
514875	32	7,5	Small blade fuses, brown	89
604830	32	30	Type B, pink	97
604840	32	40	Type B, green	97
604850	32	50	Type B, red	97
604860	32	60	Type B, yellow	97
604870	32	70	Type B, brown	97
604880	32	80	Type B, black	97
604900	32	100	Type B, blue	97
604920	32	120	Type B, white	97
604940	32	140	Type B, dark red	97
605020	32	20	Type AS, blue	97
605030	32	30	Type AS, pink	97
605040	32	40	Type AS, green	97



Product index

Sicherungen · Fuses · Fusibles · Fusibles

Type	V	A	i	P.
605050	32	50	Type AS, red	97
605060	32	60	Type AS, yellow	97
606830	32	30	Type CS, pink	98
606840	32	40	Type CS, green	98
606850	32	50	Type CS, red	98
606860	32	60	Type CS, yellow	98
606870	32	70	Type CS, brown	98
606880	32	80	Type CS, black	98
607030	32	30	Type C, pink	98
607040	32	40	Type C, green	98
607050	32	50	Type C, red	98
607060	32	60	Type C, yellow	98
607080	32	80	Type C, black	98
608715	32	15	Type JMS, grey	96
608720	32	20	Type JMS, blue	96
608725	32	25	Type JMS, white	96
608730	32	30	Type JMS, pink	96
608740	32	40	Type JMS, green	96
608750	32	50	Type JMS, red	96
608760	32	60	Type JMS, yellow	96
608815	32	15	Type J micro, grey	96
608820	32	20	Type J micro, blue	96

Type	V	A	i	P.
608825	32	25	Type J micro, white	96
608830	32	30	Type J micro, pink	96
608840	32	40	Type J micro, green	96
608920	32	20	Type J small, blue	95
608925	32	25	Type J small, white	95
608930	32	30	Type J small, pink	95
608940	32	40	Type J small, green	95
608950	32	50	Type J small, red	95
608960	32	60	Type J small, yellow	95
609020	32	20	Type J blue	95
609025	32	25	Type J, white	95
609030	32	30	Type J, pink	95
609040	32	40	Type J, green	95
609050	32	50	Type J, red	95
609060	32	60	Type J, yellow	95
609545	32	45	Type E, red	98
609565	32	65	Type E, black	98
609575	32	75	Type E, grey	98
1014005	32	0,5	Glass fuses, 5x20 mm, quick	94
1014010	32	1	Glass fuses, 5x20 mm, quick	94
1014012	32	1,25	Glass fuses, 5x20 mm, quick	94
1014016	32	1,6	Glass fuses, 5x20 mm, quick	94



Product index

Sicherungen · Fuses · Fusibles · Fusibles

Type	V	A	i	P.
1014020	32	2	Glass fuses, 5x20 mm, quick	94
1014025	32	2,5	Glass fuses, 5x20 mm, quick	94
1014031	32	3,15	Glass fuses, 5x20 mm, quick	94
1014040	32	4	Glass fuses, 5x20 mm, quick	94
1014050	32	5	Glass fuses, 5x20 mm, quick	94
1014063	32	6,3	Glass fuses, 5x20 mm, quick	94
1014100	32	10	Glass fuses, 5x20 mm, quick	94
1014150	32	15	Glass fuses, 5x20 mm, quick	94
3148100	32	100	Big blade fuses, violet	88
6068100	32	100	Type CS, blue	98
6068120	32	120	Type CS, white	98
6068140	32	140	Type CS, dark red	98
6070100	32	100	Type C, blue	98
6070120	32	120	Type C, white	98
6091050	58	50	ET fuses, red	99
6091060	58	60	ET fuses, yellow	99
6091070	58	70	ET fuses, brown	99
6091080	58	80	ET fuses, black	99
6091100	58	100	ET fuses, blue	99
6091125	58	125	ET fuses, pink	99
6091150	58	150	ET fuses, grey	99
7048030	58	30	European bolt-on fuses small, orange	92

Type	V	A	i	P.
7048040	58	40	European bolt-on fuses small, green	92
7048050	58	50	European bolt-on fuses small, red	92
7048060	58	60	European bolt-on fuses small, yellow	92
7048070	58	70	European bolt-on fuses small, brown	92
7048080	58	80	European bolt-on fuses small, white	92
7048100	58	100	European bolt-on fuses small, blue	92
7048125	58	125	European bolt-on fuses small, pink	92
7048150	58	150	European bolt-on fuses small, grey	92
7048175	58	175	European bolt-on fuses small, light brown	92
7048200	58	200	European bolt-on fuses small, violet	92
8048080	32	80	European bolt-on fuses big, red	93
8048100	32	100	European bolt-on fuses big, yellow	93
8048125	32	125	European bolt-on fuses big, green	93
8048150	32	150	European bolt-on fuses big, orange	93
8048175	32	175	European bolt-on fuses big, white	93
8048200	32	200	European bolt-on fuses big, blue	93
8048225	32	225	European bolt-on fuses big, light brown	93
8048250	32	250	European bolt-on fuses big, pink	93
8048300	32	300	European bolt-on fuses big, grey	93
8048350	32	350	European bolt-on fuses big, dark green	93
8048400	32	400	European bolt-on fuses big, violet	93



Product index

Sicherungen · Fuses · Fusibles · Fusibles

Type	V	A	i	P.
8048450	32	450	European bolt-on fuses big, yellow ochre	93
8048500	32	500	European bolt-on fuses big, brown	93
8058080	70	80	European bolt-on fuses big, red	93
8058100	70	100	European bolt-on fuses big, yellow	93
8058125	70	125	European bolt-on fuses big, green	93
8058150	70	150	European bolt-on fuses big, orange	93
8058175	70	175	European bolt-on fuses big, white	93
8058200	70	200	European bolt-on fuses big, blue	93
8058225	70	225	European bolt-on fuses big, light brown	93
8058250	70	250	European bolt-on fuses big, pink	93
8058300	70	300	European bolt-on fuses big, grey	93
8058350	70	350	European bolt-on fuses big, dark green	93
8058400	70	400	European bolt-on fuses big, violet	93
8058450	70	450	European bolt-on fuses big, dark yellow	93
8058500	70	500	European bolt-on fuses big, brown	93
9048050	58	50	Compact fuses	100
9048075	58	75	Compact fuses	100
9048100	58	100	Compact fuses	100
9048125	58	125	Compact fuses	100
9048150	58	150	Compact fuses	100
9048175	58	175	Compact fuses	100
9048200	58	200	Compact fuses	100

Type	V	A	i	P.
9048250	58	250	Compact fuses	100
9048300	58	300	Compact fuses	100
EVM40001	450	1	EV fuses	102
EVM40005	450	5	EV fuses	102
EVM50015	500	15	EV fuses	102
EVM50020	500	20	EV fuses	102
EVM50030	500	30	EV fuses	102
EVM50040	500	40	EV fuses	102
EVM50050	450	50	EV fuses	102
EVM60060	500	60	EV fuses	102
EVM60070	500	70	EV fuses	102
EVM60080	500	80	EV fuses	102
EVM60100	500	100	EV fuses	102
EVM60125	500	125	EV fuses	102
EVM80150	500	150	EV fuses	103
EVM80175	500	175	EV fuses	103
EVM80200	500	200	EV fuses	103
EVM80225	500	225	EV fuses	103
EVM80250	500	250	EV fuses	103
EVM80300	500	300	EV fuses	103
EVM80350	500	350	EV fuses	103
EVM80400	500	400	EV fuses	103



Product index

Sicherungen · Fuses · Fusibles · Fusibles

Type	V	A	i	P.
EVM80450	500	450	EV fuses	103
EVM80500	500	500	EV fuses	103
EVM100600	500	600	EV fuses	103
EVM100700	500	700	EV fuses	103
EVM100800	500	800	EV fuses	103
EVM100900	500	900	EV fuses	103
EVM101000	500	1000	EV fuses	103

Type	i	P.
1020	Fuse holder, blade terminals, made from bakelit	105
1110	Fuse holder with blade terminals and cap, connectable	105
1135	Fuse holder, crimp contacts and cap	105
2211	Fuse holder, crimp contacts, connectable to relay socket 2222	105
6302	Inline fuse holder for 5028xx micro II fuses, waterproof, with cable	104
6303	Fuse holder for 5018xx micro III fuses, with cable	104
6306	Fuse holder, inline fuse holder for plug-in fuses, waterproof, with cable	104
6307	Fuse holder, inline fuse holder for small plug-in fuses, waterproof, with cable	104
6308	Fuse holder, for jap. mini fuses	104
6309	Fuse holder, for small plug-in fuses	104
121400	Fuse holder, inline fuse holder	104
124800	Fuse holder, inline fuse holder for ceramic fuses, incl. 8 A fuse	104
178200	Fuse holder, blade terminals, connectable	105
234600	Fuse box with 6 slots for plug-in fuses	108
234800	Fuse box with 8 slots for plug-in fuses	108
324800	Fuse holder, for 3248xx, screw connection	106
324822	Fuse holder, cover for 324800	106
324844	Fuse holder, fuse holder 324800 and cover 324822	106
324860	fuse holder for 3148xx with cable from 2,5 mm ² - 6 mm ²	106
324870	fuse holder for 3148xx with cable from 6 mm ² - 10 mm ²	106
372400	Fuse holder, for 4 Midi fuses with 200 A max.	107
630501	Circuit+ Fuse holder, additional cicuit for micro II fuses with 10 A max.	109



Product index

Sicherungshalter · Fuse holders · Porte fusibles · Porta fusibles

Type	i	P.
630601	Circuit+ Fuse holder, additional circuit for regular blade fuses with 15 A max.	109
630603	fuse holder mount for 6306	104
630701	Circuit+ Fuse holder, additional circuit for mini fuses with 15 A max.	109
630801	Circuit+ Fuse holder, additional circuit for mini low profile fuses with 10 A max.	109
724800	Fuse holder, for 7048xxx	107
824800	Fuse holder, for 8048xxx	107
924801	Battery clamp, for 9048xxx, straight	100
924801R	Battery clamp, right cover for 924801	100
924801L	Battery clamp, left cover for 924801	100
924802	Battery clamp, for 9048xxx, 90° angle	100

Relais und Blinkgeber · Relays and flashers · Relais et centrales clignotantes · Relés y destelladores

Type	V	A	i	P.
1044	12	20	Ultra micro relay, with resistance	121
1064	12	20/10	Ultra micro relay, with resistance	121
1141	12	20	Normally open micro relay	120
1142	12	25	Normally open micro relay	120
1143	12	25	Normally open micro relay	120
1144	12	25	Normally open micro relay	120
1162	12	15/25	Changeover micro relay	121
1163	12	15/25	Changeover micro relay, with diode	121
1164	12	15/25	Changeover micro relay, with resistance	121
1443	24	10	Normally open micro relay	120
1462	24	5/10	Changeover micro relay	121
1463	24	5/10	Changeover micro relay, with diode	121
1464	24	5/10	Changeover micro relay, with resistance	121
1465	24	10/15	Changeover micro relay, with resistance	121
2142	12	30	Normally open relay, 4 Pins	116
2143	12	30	Normally open relay, 4 Pins, with resistance	116
2144	12	40	Normally open relay, 4 Pins	116
2162	12	20/30	Changeover relay, with bracket	118
2242	12	30	Normally open relay, 4 Pins	116
2243	12	30	Normally open relay, 4 Pins, with fuse	116
2245	12	40	Normally open relay, 4 Pins, with resistance	116
2248	12	50	High power relay, with bracket	119



Product index

Relais und Blinkgeber · Relays and flashers · Relais et centrales clignotantes · Relés y destelladores

Type	V	A	İ	P.
2252	12	30	Normally open relay, 5 Pins	117
2254	12	40	Normally open relay, 5 Pins	117
2255	12	30	Normally open relay, 5 Pins, with bracket, with diode	117
2262	12	20/30	Changeover relay, with bracket	118
2263	12	20/30	Changeover relay, with bracket, with resistance	118
2264	12	70/60	High power changeover, with bracket	120
2265	12	20/30	Changeover relay, with bracket, with diode	118
2268	12	30/40	Changeover relay, with bracket, high power	118
2270	12	70	High power relay, with bracket	119
2271	12	70	High power relay, with bracket, with diode	119
2273	12	70	High power relay, with bracket, with resistance	119
2274	24	40	High power relay, with bracket	119
2275	24	70	High power relay, with bracket, small housing	119
2276	24	70	High power relay, with bracket, with diode, small housing	119
4142	24	20	Normally open relay, 4 Pins	116
4143	24	20	Normally open relay, 4 Pins, with resistance	116
4162	24	10/20	Changeover relay, with bracket	118
4242	24	20	Normally open relay, 4 Pins	116
4243	24	20	Normally open relay, 4 Pins, with fuse	116
4252	24	20	Normally open relay, 5 Pins	117
4254	24	30	Normally open relay, 5 Pins	117
4262	24	10/20	Changeover relay, with bracket	118

Relais und Blinkgeber · Relays and flashers · Relais et centrales clignotantes · Relés y destelladores

Type	V	A	i	P.
4263	24	10/20	Changeover relay, with bracket, with resistance	118
4264	24	40/30	High power changeover, with bracket	120
4265	24	10/20	Changeover relay, with bracket, with diode	118
4268	24	20/30	Changeover relay, with bracket, high power	118
9242	12	200	Heavy Duty high power relay, big housing	119
9458	12	150	Smart battery relay	122
162917	12		Wiper relay	124
1321240	12	40	Normally open relay, with bracket	116
1620002	12		Flasher unit, 2 terminals, LED only, max. 30 W	126
1620003	12		Flasher unit, 3 terminals, LED only, max. 30 W	126
1621002	12		Flasher unit, 2 terminals, max. 300 W	126
1621003	12		Flasher unit, 3 terminals, max. 300 W	126
1622411	12		Flasher unit, 3 terminals, 2/4x21 W, no bracket, small version	126
1622421	12		Flasher unit, 3 terminals, 2/4x21 W	126
1622425	12		Flasher unit, 4 terminals, 2/4x21 W, SAE standard	126
1628821	12/24		Flasher unit, 6 terminals	127
1632421	24		Flasher unit, 3 terminals, max. 170 W	127
1634852	12/24		Flasher unit, 11 terminals, max. 170 W, no control of flashing bulbs	127
1641002	24		Flasher unit, 2 terminals, max. 150 W	127
1641003	24		Flasher unit, 3 terminals, max. 150 W	127
1642421	24		Flasher unit, 3 terminals, 2/4x21 W	127



Product index

Signalhörner · Signal horns · Avertisseurs · Bocinas

Type	V	i	P.
63359	6	Disc horn, 91 mm diameter, 340 Hz	130
123357	12	Disc horn, 70 mm diameter, 340 Hz, 71,5x41x95 mm	130
123359	12	Disc horn, 91 mm diameter, 340 Hz, 91x56x115 mm	130
124307	12	Disc horn, 70 mm diameter, 430 Hz, 71,5x41x95 mm	130
124309	12	Disc horn, 91 mm diameter, 430 Hz, 91x56x115 mm	130
127659	12	Disc horn, set of 123359 and 124309	130
128097	12-80	Back-up alarm, 97 dB, contains additional relay	133
129206	12	Fanfare horn, set of one 410 Hz and one 500 Hz fanfare horn	131
243359	24	Disc horn, 91 mm diameter, 340 Hz, 91x56x115 mm	130
244309	24	Disc horn, 91 mm diameter, 430 Hz, 91x56x115 mm	130
247659	24	Disc horn, set of 123359 and 124309	131
249206	24	Fanfare horn, set of one 410 Hz and one 500 Hz fanfare horn	131
483359	48	Disc horn, 91 mm diameter, 340 Hz, 91x56x115 mm	131
11690120	12	Ultra air horn, two tone air compressor horn, HIGH 660 Hz, LOW 520 Hz, ≥ 112 dB at 2 m	132
11690122	12	Ultra air horn, two tone air compressor horn, HIGH 660 Hz, LOW 520 Hz, ≥ 112 dB at 2 m, chrome finish	132
11690124	24	Ultra air horn, two tone air compressor horn, HIGH 660 Hz, LOW 520 Hz, ≥ 112 dB at 2 m	132
11690220	24	Ultra air horn, low tone air compressor horn, 300 Hz, ≥ 112 dB at 2 m	133
11690240	24	Ultra air horn, low tone air compressor horn, 300 Hz, ≥ 112 dB at 2 m	133
11690320	12	Ultra air horn, two tone air compressor horn, HIGH 660 Hz, LOW 520 Hz, ≥ 112 dB at 2 m, separate compressor	133

Type	V	i	P.
1122		Micro relay socket, no bracket	143
1123		Micro relay socket, with bracket	143
1444		Bulb holder, for H1	138
1445		Bulb holder, for H1	138
2222		Mini relay socket, for relays with 6,3 mm pins	142
2223		Mini relay socket, for high power relays	142
2224		Mini relay socket, for high power changeover relays	142
2444		Bulb holder, for bulbs with socket W3x16d, incl. cables	140
2644		Bulb holder, for bulbs with socket W3x16q, incl. cables	140
3444		Bulb holder, for bulbs with socket W2,5x16d, incl. cables	141
3644		Bulb holder, for bulbs with socket W2,5x16q, incl. cables	141
4041		Bulb holder, for bulbs with socket BA9s, incl. cables	141
4144		Bulb holder, for bulbs with socket W2x4,6d, incl. cables	141
4244		Bulb holder, for bulbs with socket W2,1x9,5d	141
4245		Bulb holder, for bulbs with socket W2,1x9,5d, incl. cables	141
4444		Bulb holder, for H4, requires 2,5 mm ² cables	138
4445		Bulb holder, for H4, incl. cables	138
4446		Bulbholder, ceramic, for high wattage H4, incl. cables	138
5444		Bulb holder, for bulbs with socket BAY15d, incl. cables	140
6444		Bulb holder, for bulbs with socket BA15s, incl. cables	140
6445		Bulb holder, for bulbs with socket BAU15s, incl. cables	140
7444		Bulb holder, for H7, incl. cables	138



Product index

Zubehör · Accessories · Accessoires · Accesorios

Type	V	i	P.
7446		Bulb holder, for H7, incl. cables, ceramic	138
8004		Spare lamp kit, grey foam, H4 kit	145
8007		Spare lamp kit, grey foam, H7 kit	145
8017		Spare lamp kit, grey foam, H1 and H7 kit	145
8031		Spare lamp kit, grey foam, 6V ASY	145
8032		Spare lamp kit, grey foam, 6V SYM	145
8039		Spare lamp kit, grey foam, 12V ASY	145
8044		Spare lamp kit, grey foam, 24V H4 kit	146
8201		Spare lamp kit, yellow box, H1 kit	146
8204		Spare lamp kit, yellow box, H4 kit	146
8207		Spare lamp kit, yellow box, H7 kit	146
8405		Spare lamp kit, grey foam, double 24V H4 kit	146
8407		Spare lamp kit, grey foam, double 24V H7 kit	146
9440		Bulb holder, for 880, 893, and 890, incl. cables	139
9441		Bulb holder, for 881, 886, 894 and 896, incl. cables	139
9444		Bulb holder, for 9004 and 9007, incl. cables	139
9445		Bulb holder, for HB3, H10, H12 and HIR1, incl. cables	139
9446		Bulb holder, for HB4 and HIR2, incl. cables	139
9448		Bulb holder, for H8, H9 and H11, incl. cables	139
9449		Bulb holder, for H13/9008, incl. cables	139
14442		Bulb holder, for H1, incl. cables	138
16560		Fuse tester and puller	137

Type	V	i	P.
16552		Fuse puller for plug-in fuses	137
18900		Sales display, metal lamp cabinet	156
80200		Workshop kit, assorted small bulbs	147
112305		Micro relay socket, with pins	143
112310		Micro relay socket, with cable and pins	143
120010		Horn adapter for VW + Mercedes	144
120011		Horn adapter for VW (old type)	144
120020		Horn adapter for Peugeot	144
120021		Horn adapter for Peugeot (new type)	144
120030		Horn adapter for Jaguar	144
120040		Horn adapter for Ford	144
120050		Horn adapter for BMW	144
120060		Horn adapter for Toyota	144
151511	24	Cigarette lighter, with LED light	136
181399	12/24	Power adapter, with cover	136
181400	12	Power adapter, with cover and light	136
181403	12	Cigarette lighter, no light, big button	136
181420	12/24	Universal plug, incl. 8 A fuse, fits cigarette lighters and power adapters	137
181500	12	Power adapter, with cover and LED light	136
181504	12	Cigarette lighter, with LED light	136
181507	12	Cigarette lighter, with LED light, small button	136
181512	24	Power adapter, with cover and LED light	136



Product index

Zubehör · Accessories · Accessoires · Accesorios

Type	V	i	P.
181740	12/24	DC 12-24 V 20 W 1x USB-A 1x USB-C	137
183000	6-24	Bulb tester	137
183044	6-24	Voltager tester	137
213010		Fuse kit, small blade fuse kit	149
213020		Fuse kit, jap. miniature blade fuse kit	150
213040		Fuse kit, regular blade fuse kit	151
213050		Fuse kit, mixed blade fuse kit	148
213070		Fuse kit, mixed fuse kit	154
213080		Fuse kit, small blade fuse kit, 10 spaces	153
213090		Fuse kit, regular blade fuse kit, 10 spaces	152
222205		Mini relay socket, for relays with 6,3 mm pins, incl. pins	142
222210		Mini relay socket, for relays with 6,3 mm pins, incl. cables and pins	142
222305		Mini relay socket, for high power relays, incl. pins	142
222310		Mini relay socket, for high power relays, incl. cables and pins	142
222405		Mini relay socket, for high power changeover relays, incl. pins	142
222410		Mini relay socket, for high power changeover relays, incl. cables and pins	142
300054	12	Worklight, 270° adjustable LED 250-500 lm 4-7,5 h battery life	136

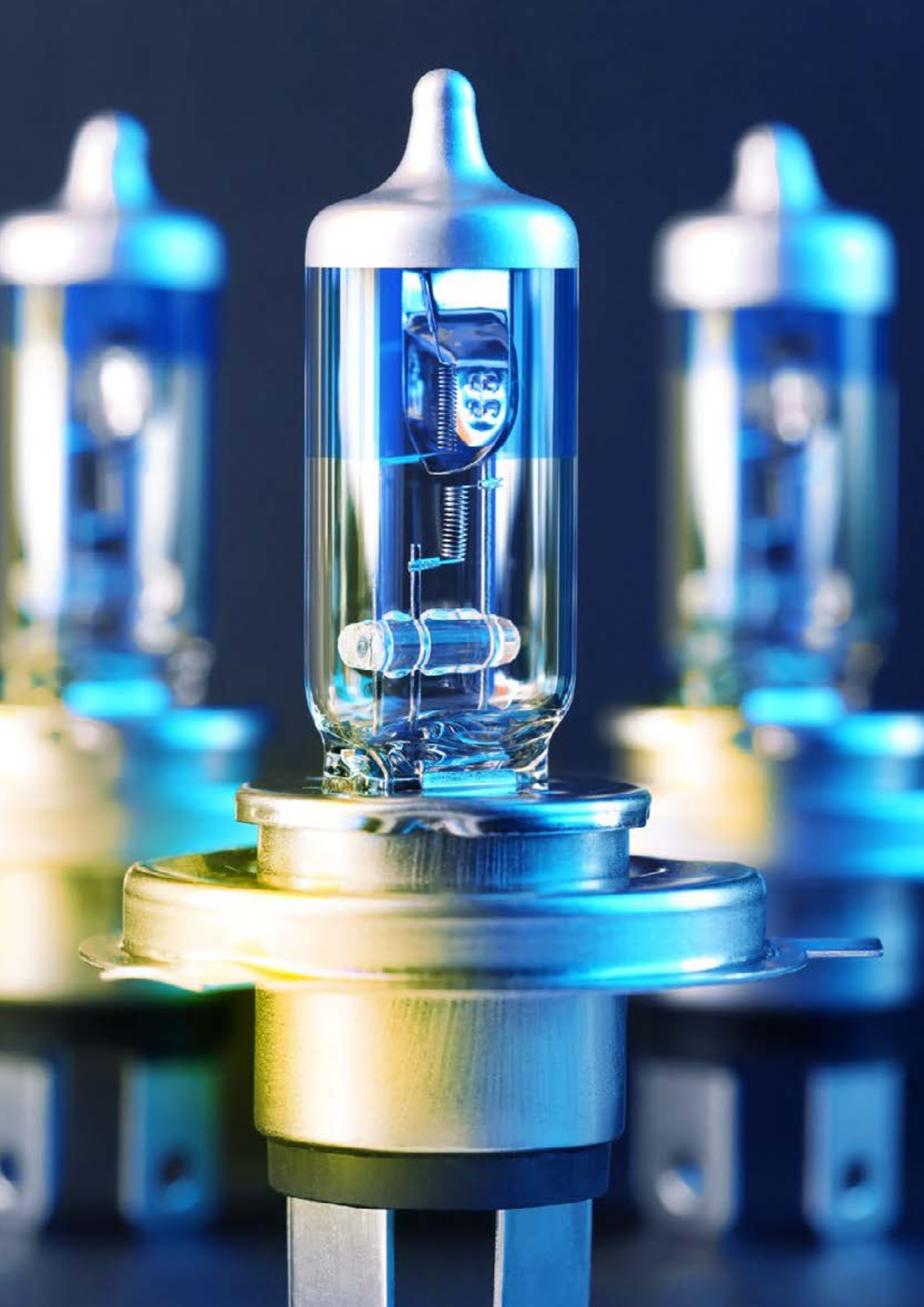



Flösser GmbH & Co. KG

P. O. Box 1780 · 54207 Trier/Germany
www.flosser.com · flosser@flosser.com

